

R82 x:panda

CAD Retail Price List/ Order Form

Account #: _____ Purchase Order No.: _____ Date: _____
 Contact: _____ Mark For: _____

Bill To:	Ship To:
Address:	Address:
City/State/Zip:	
Phone:	City/State/Zip:
Email	Phone:

US Configuration

Effective: 01.10.24 - Rev 9

- x:panda
- Cushions
- Head support
- Side support/overarm support
- Armrest
- Wedges
- Vests and belts
- Tray
- Frame
- Push brace
- Foot support



- A (Back Height) _____
- B (Arm Height) _____
- C (Lower Leg Length) _____
- D (Seat Depth) _____
- E (Chest Width) _____
- F (Seat Width) _____
- G (Height from Seat to Top of Head) _____
- H (Shoulder Width) _____
- Age _____
- Weight _____

Measurements

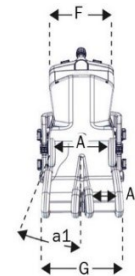
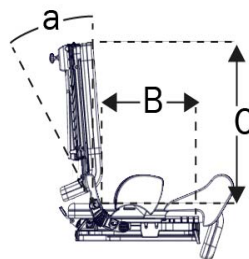

	Size 1 Inches	Size 2 Inches	Size 3 Inches	Size 4 Inches
Effective Seat Width (A)	6¼", 7¾", 9½"	7¼", 9½", 11"	10¼", 12¼", 14¼"	13½", 15¾", 18"
Armrest Width	6¼"-8¾"	7¾"-10¼"	10¼"-12½"	13½"-15¾"
	7¾"-10¼"	9½"-11¾"	12¼"-14½"	15¾"-18"
	9½"-11¾"	11"-13½"	14¼"-16½"	18"-20½"
Width, Thighs (A1)	2¾", 3½", 4¼"	4", 4¾", 5½"	4¾", 5¾", 6¾"	5", 7½", 9¾"
Effective Seat Depth (B)	6¼"-10¼"	7¼"-11¾"	10¼"-15¼"	15¼"-20¾"
Backrest Height (C)	10½"-14½"	12½"-16½"	13¾"-18½"	19¾"-28"
Back Width, Top (F)	9"	11"	13"	13¾" +2"
Overall Width, Max Abduction (G)	12¼", 13¾", 15¼"	15", 16½", 18"	18½", 20½", 22½"	23¼", 25½", 28"
Backrest Angle (a)	-5° - +30°	-5° - +30°	-5° - +30°	-5° - +30°
Abduction Angle, Each Leg (a1)	0° - 8°, 15°, 15°	0° - 15°, 15°, 15°	0° - 15°, 15°, 15°	0° - 15°, 15°, 15°
Total Mass	14.3 lbs.	18.7 lbs.	28.3 lbs.	28½ lbs.
Max Load	66.1 lbs.	66.1 lbs.	132.3 lbs.	176.4 lbs.
Max Load at Transportation	66.1 lbs.	66.1 lbs.	132.3 lbs.	165.3 lbs.
Approx. Min. User Height	25½"	33½"	39½"	55"
Approx. Max User Height	41¼"	48½"	56"	72½"

NOTES:

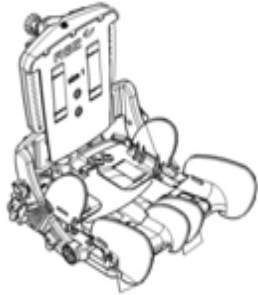

- Height, Depth and Angle Adjustable Back
- Angle Adjustable Adduction
- Width and Depth Adjustable Seat - *Includes Blocks for size adjustments*

Description	Size	Part No.	CAD Price
NOTE → <i>The x:panda comes in 4 sizes, each of which can be set at one of the 3 seat widths with the included sizing blocks. The seat depth easily adjusts and the seat upholstery is made to accommodate seat depth growth. The size 4 backrest width can be increased by 2" with a backrest extension kit.</i>			
<input type="checkbox"/> x:panda, size 1, Small ●●	1	8910111-02	
<input type="checkbox"/> x:panda, size 1, Small Back ●●	1	X8910111-01	\$867
<input type="checkbox"/> x:panda, size 1, Small Seat ●●	1	X8910111-02	\$889
●●Custom order; Approx. lead time: 6-8 weeks. Non-returnable item			
<input type="checkbox"/> x:panda, size 1, Medium	1	8910112-02	
<input type="checkbox"/> x:panda, size 1, Medium Back	1	X8910112-01	\$867
<input type="checkbox"/> x:panda, size 1, Medium Seat	1	X8910112-02	\$886
<input type="checkbox"/> x:panda, size 1, Large ●●	1	8910113-02	
<input type="checkbox"/> x:panda, size 1, Large Back ●●	1	X8910113-01	\$867
<input type="checkbox"/> x:panda, size 1, Large Seat ●●	1	X8910113-02	\$889
●●Custom order; Approx. lead time: 6-8 weeks. Non-returnable item			
<input type="checkbox"/> x:panda, size 2, Small	2	8910121-02	
<input type="checkbox"/> x:panda, size 2, Small Back	2	X8910121-01	\$867
<input type="checkbox"/> x:panda, size 2, Small Seat	2	X8910121-02	\$889
<input type="checkbox"/> x:panda, size 2, Medium	2	8910122-02	
<input type="checkbox"/> x:panda, size 2, Medium Back	2	X8910122-01	\$867
<input type="checkbox"/> x:panda, size 2, Medium Seat	2	X8910122-02	\$889
<input type="checkbox"/> x:panda, size 2, Large ●●	2	8910123-02	
<input type="checkbox"/> x:panda, size 2, Large Back ●●	2	X8910123-01	\$867
<input type="checkbox"/> x:panda, size 2, Large Seat ●●	2	X8910123-02	\$889
●●Custom order; Approx. lead time: 6-8 weeks. Non-returnable item			
<input type="checkbox"/> x:panda, size 3, Small	3	8910131-02	
<input type="checkbox"/> x:panda, size 3, Small Back	3	X8910131-01	\$867
<input type="checkbox"/> x:panda, size 3, Small Seat	3	X8910131-02	\$889
<input type="checkbox"/> x:panda, size 3, Medium	3	8910132-02	
<input type="checkbox"/> x:panda, size 3, Medium Back	3	X8910132-01	\$867
<input type="checkbox"/> x:panda, size 3, Medium Seat	3	X8910132-02	\$889
<input type="checkbox"/> x:panda, size 3, Large	3	8910133-02	
<input type="checkbox"/> x:panda, size 3, Large Back	3	X8910133-01	\$867
<input type="checkbox"/> x:panda, size 3, Large Seat	3	X8910133-02	\$889
<input type="checkbox"/> x:panda, size 4, Small	4	8910141-02	
<input type="checkbox"/> x:panda, size 4, Small Back	4	X8910141-01	\$867
<input type="checkbox"/> x:panda, size 4, Small Seat	4	X8910141-02	\$889
<input type="checkbox"/> x:panda, size 4, Medium	4	8910142-02	
<input type="checkbox"/> x:panda, size 4, Medium Back	4	X8910142-01	\$867
<input type="checkbox"/> x:panda, size 4, Medium Seat	4	X8910142-02	\$889
<input type="checkbox"/> x:panda, size 4, Large ●●	4	8910143-02	
<input type="checkbox"/> x:panda, size 4, Large Back ●●	4	X8910143-01	\$867
<input type="checkbox"/> x:panda, size 4, Large Seat ●●	4	X8910143-02	\$889
●●Custom order; Approx. lead time: 6-8 weeks. Non-returnable item			

Accessories	Description	Measurements	Size	Part No.	CAD Price
-------------	-------------	--------------	------	----------	-----------

Requirement - A Dynamic or Non-Dynamic Gas Spring must be selected

Dynamic Back with Recline Options



<input type="checkbox"/>	Dynamic Back, 50 Newton Gas Spring ••		1, 2	8911050	\$939
<input type="checkbox"/>	Dynamic Back, 100 Newton Gas Spring (Std on sz 1,2)		1, 2	X8911100	\$939
<input type="checkbox"/>	Dynamic Back, 150 Newton Gas Spring ••		1, 2	8911125	\$939
<input type="checkbox"/>	Dynamic Back, 150 Newton Gas Spring (Std on sz 3)		3	X8911150	\$939
<input type="checkbox"/>	Dynamic Back, 250 Newton Gas Spring		3	8911250	\$939
<input type="checkbox"/>	Dynamic Back, 300 Newton Gas Spring ••		3	8911300	\$939
<input type="checkbox"/>	Dynamic Back, 350 Newton Gas Spring (Std on sz 4)		4	X8911350-4	\$939

••Custom order; Approx. lead time: 6-8 weeks. Non-returnable item

Non-Dynamic Back with Recline Options

<input type="checkbox"/>	Non-Dynamic Gas Spring		1, 2	8911001	\$578
<input type="checkbox"/>	Non-Dynamic Gas Spring		3	8911002	\$578

<input type="checkbox"/>	Recline, '-5° to 30° ♦		One Size	X66-8911	\$578
--------------------------	------------------------	--	----------	----------	-------

♦ Required with Dynamic Back

<input type="checkbox"/>	Fixed Rod; Non-Reclining ••		4	8911504	\$0
--------------------------	-----------------------------	--	---	---------	-----

Description	Measurements	Size	Part No.	CAD Price
-------------	--------------	------	----------	-----------

Please Select a Color

XX = Color

<input type="checkbox"/>	Black = 60	<input type="checkbox"/>	Pink = 64 (n/a on sz 4)
<input type="checkbox"/>	Blue = 66	<input type="checkbox"/>	Red = 65

*Color Lime Green available as a custom order; Approx. lead time: 6-8 weeks. Non-returnable item

Requirement - A cushion must be selected.

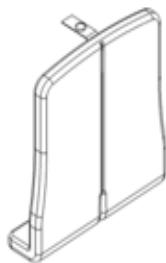

<input type="checkbox"/>	Back Cushion, size 1, Small	6¼" Width	1	8912211-xx	\$0
<input type="checkbox"/>	Back Cushion, size 1, Medium	7¼" Width	1	8912212-xx	\$0
<input type="checkbox"/>	Back Cushion, size 1, Large	9¼" Width	1	8912213-xx	\$0
<input type="checkbox"/>	Back Cushion, size 2, Small	7¼" Width	2	8912221-xx	\$0
<input type="checkbox"/>	Back Cushion, size 2, Medium	9¼" Width	2	8912222-xx	\$0
<input type="checkbox"/>	Back Cushion, size 2, Large	11" Width	2	8912223-xx	\$0
<input type="checkbox"/>	Back Cushion, size 3, Small	10¼" Width	3	8912231-xx	\$0
<input type="checkbox"/>	Back Cushion, size 3, Medium	12" Width	3	8912232-xx	\$0
<input type="checkbox"/>	Back Cushion, size 3, Large	14" Width	3	8912233-xx	\$0
<input type="checkbox"/>	Back Cushion, size 4, Small	14¼" Width	4	8912241-xx	\$0
<input type="checkbox"/>	Back Cushion, size 4, Medium	16" Width	4	8912242-xx	\$0
<input type="checkbox"/>	Back Cushion, size 4, Large	18" Width	4	8912243-xx	\$0

Incontinence Proof Back Cover

<input type="checkbox"/>	Seat Cover, Incontinence Proof*		1, 2, 3	89124xx-82	\$151
<input type="checkbox"/>	Seat Cover, Incontinence Proof*		4	89124xx-82	\$356

Please Select a Size

Size 1	Size 2	Size 3	Size 4
<input type="checkbox"/> Small = 11	<input type="checkbox"/> Small = 21	<input type="checkbox"/> Small = 31	<input type="checkbox"/> Small = 41
<input type="checkbox"/> Medium = 12	<input type="checkbox"/> Medium = 22	<input type="checkbox"/> Medium = 32	<input type="checkbox"/> Medium = 42
<input type="checkbox"/> Large = 13	<input type="checkbox"/> Large = 23	<input type="checkbox"/> Large = 33	<input type="checkbox"/> Large = 43



<input type="checkbox"/>	Backrest Height Extension Kit *		4	8910409-45	\$326
--------------------------	---------------------------------	--	---	------------	-------



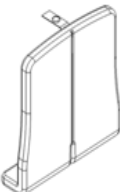

* This kit adds 2" in backrest height. Only available on sz 4.



<input type="checkbox"/>	Extended Back Cushion, sz 4, SM* • 16¼" Width		4	8910344-xx	\$0
<input type="checkbox"/>	Extended Back Cushion, sz 4, MD* • 18" Width		4	8910345-xx	\$0
<input type="checkbox"/>	Extended Back Cushion, sz 4, LG* • 20" Width		4	8910346-xx	\$0

* To be used with Backrest Extension Kit

••Custom order; Approx. lead time: 6-8 weeks.

Accessories	Description	Measurements	Size	Part No.	CAD Price
	<input type="checkbox"/> Backrest Extension, Small ●●	9" x 3.9" x 2"	One Size	8910655-160	\$311
	<input type="checkbox"/> Backrest Extension, Medium ●●	11" x 3.9" x 2"	One Size	8910655-260	\$311
	<input type="checkbox"/> Backrest Extension, Large ●●	13" x 3.9" x 2"	One Size	8910655-360	\$311
●●Custom order; Approx. lead time: 6-8 weeks. Non-returnable item					
	<input type="checkbox"/> Lumbar Support		1,2,3	8910407	\$81
	<input type="checkbox"/> Insert for Backrest, Foam *	8¼" x 4"	1	8910406-1	\$52
	<input type="checkbox"/> Insert for Backrest, Foam *	9¾" x 4"	2	8910406-2	\$52
	<input type="checkbox"/> Insert for Backrest, Foam *	11¾" x 5¾"	3	8910406-3	\$52
*Used to fill in a gap when the backrest height is set in an uppermost position					
	<input type="checkbox"/> Insert for Backrest, Plywood *	3½" x 13½"	4	8910406-4	\$133
*Used to fill in a gap when the backrest height is set in an uppermost position					

Description	Measurements	Size	Part No.	CAD Price
-------------	--------------	------	----------	-----------

Please Select a Color

XX = Color

- Black = 60 Pink = 64 (n/a on sz 4)
 Blue = 66 Red = 65

***Color Lime Green available as a custom order; Approx. lead time: 6-8 weeks. Non-returnable item**

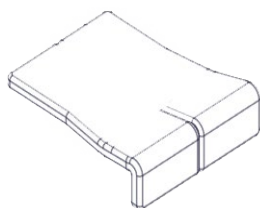

<input type="checkbox"/> Split Seat Cushion, sz 1, Small	6¼" Width	1	8911211-xx	\$0
<input type="checkbox"/> Split Seat Cushion, sz 1, Medium	7¼" Width	1	8911212-xx	\$0
<input type="checkbox"/> Split Seat Cushion, sz 1, Large	9¼" Width	1	8911213-xx	\$0
<input type="checkbox"/> Split Seat Cushion, sz 2, Small	7¼" Width	2	8911212-xx	\$0
<input type="checkbox"/> Split Seat Cushion, sz 2, Medium	9¼" Width	2	8911222-xx	\$0
<input type="checkbox"/> Split Seat Cushion, sz 2, Large ●●	11" Width	2	8911223-xx	\$0
<input type="checkbox"/> Split Seat Cushion, sz 3, Small	10¼" Width	3	8911231-xx	\$0
<input type="checkbox"/> Split Seat Cushion, sz 3, Medium	12" Width	3	8911232-xx	\$0
<input type="checkbox"/> Split Seat Cushion, sz 3, Large	14" Width	3	8911233-xx	\$0
<input type="checkbox"/> Split Seat Cushion, sz 4, Small	14¼" Width	4	8911241-xx	\$0
<input type="checkbox"/> Split Seat Cushion, sz 4, Medium	16" Width	4	8911242-xx	\$0
<input type="checkbox"/> Split Seat Cushion, sz 4, Large ●●	18" Width	4	8911243-xx	\$0

●●Custom order; Approx. lead time: 6-8 weeks.

Incontinence Proof Seat Cover

Seat Cover, Incontinence Proof*	1, 2, 3	89114xx-82	\$151
Seat Cover, Incontinence Proof*	4	89114xx-82	\$356

Please Select a Size

Size 1	Size 2	Size 3	Size 4
Small = 11	<input type="checkbox"/> Small = 12	<input type="checkbox"/> Small = 31	<input type="checkbox"/> Small = 41
Medium = 12	<input type="checkbox"/> Medium = 22	<input type="checkbox"/> Medium = 32	<input type="checkbox"/> Medium = 42
Large = 13	<input type="checkbox"/> Large = 23	<input type="checkbox"/> Large = 33	<input type="checkbox"/> Large = 43

***Seat cover only available for split seat upholstery**

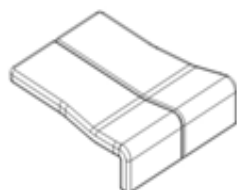

<input type="checkbox"/> Seat Cushion, sz 1, Small ●●	6¼" Width	1	8910251-60	\$0
<input type="checkbox"/> Seat Cushion, sz 1, Medium	7¼" Width	1	8910252-60	\$0
<input type="checkbox"/> Seat Cushion, sz 1, Large ●●	9¼" Width	1	8910253-60	\$0
<input type="checkbox"/> Seat Cushion, sz 2, Small ●●	7¼" Width	2	8910261-60	\$0
<input type="checkbox"/> Seat Cushion, sz 2, Medium	9¼" Width	2	8910262-60	\$0
<input type="checkbox"/> Seat Cushion, sz 2, Large ●●	11" Width	2	8910263-60	\$0
<input type="checkbox"/> Seat Cushion, sz 3, Small ●●	10¼" Width	3	8910271-60	\$0
<input type="checkbox"/> Seat Cushion, sz 3, Medium	12" Width	3	8910272-60	\$0
<input type="checkbox"/> Seat Cushion, sz 3, Large	14" Width	3	8910273-60	\$0

→Seat Upholstery is designed for use without Medial Thigh Supports. Seat cushion easily accommodates seat depth growth.

→Only available in **black**

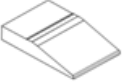
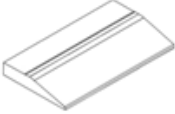
Accessories	Description	Measurements	Size	Part No.	CAD Price
	<input type="checkbox"/> Anti-Thrust Wedges (Pr.)	2½" x 6¼" x 1"	1	8910400-1	\$67
	<input type="checkbox"/> Anti-Thrust Wedges (Pr.)	3" x 6¼" x 1"	1,2	8910400-2	\$67
	<input type="checkbox"/> Anti-Thrust Wedges (Pr.)	4" x 6¼" x 1"	1,2,3	8910400-3	\$67
	<input type="checkbox"/> Anti-Thrust Wedges (Pr.)	4½" x 9½" x 1½"	2,3	8910400-4	\$67
	<input type="checkbox"/> Anti-Thrust Wedges (Pr.)	5¾" x 9½" x 1½"	3	8910400-5	\$67
	<input type="checkbox"/> Anti-Thrust Wedges, SM (Pr.)	5" x 11¾" x 2"	4	8910400-11	\$67
	<input type="checkbox"/> Anti-Thrust Wedges, MD (Pr.)	6" x 11¾" x 2"	4	8910400-12	\$67
	<input type="checkbox"/> Anti-Thrust Wedges, LG (Pr.)	7½" x 11¾" x 2"	4	8910400-13	\$67

Description	Measurements	Size	Part No.	CAD Price
<input type="checkbox"/> Abduction Supports w/ Cover		1,2	8970402-10	
<input type="checkbox"/> Abduction Supports w/ Cover, Left		1,2	X8910402-1L	\$144
<input type="checkbox"/> Abduction Supports w/ Cover, Right		1,2	X8910402-1R	\$144
<input type="checkbox"/> Abduction Supports w/ Cover		3	8910402-20	\$256
<input type="checkbox"/> Abduction Supports w/ Cover, Left		3	X8910402-2L	\$144
<input type="checkbox"/> Abduction Supports w/ Cover, Right		3	X8910402-2R	\$144
<input type="checkbox"/> Abduction Supports w/ Cover		4	8910402-40	\$256
<input type="checkbox"/> Abduction Supports w/ Cover, Left		4	X8910402-4L	\$144
<input type="checkbox"/> Abduction Supports w/ Cover, Right		4	X8910402-4R	\$144

HCPCS - E0957 for Medical Thigh Support and E1028 for Removable Hardware

<input type="checkbox"/> Medial Thigh System ●●	3½" x 3½" x 3½"	One Size	8910408-1	\$491
<input type="checkbox"/> Medial Thigh System	4¾" x 3½" x 3½"	One Size	8910408-2	\$491
<input type="checkbox"/> Medial Thigh System	6" x 3½" x 3½"	One Size	8910408-3	\$491
<input type="checkbox"/> Medial Thigh System ●●	7" x 3½" x 3½"	One Size	8910408-4	\$491

●●Custom order; Approx. lead time: 6-8 weeks.

Allows for finely adjusting seat width

<input type="checkbox"/> Hip Supports, Right (Ea.)		1,2	X8910404-1R	\$144
<input type="checkbox"/> Hip Supports, Left (Ea.)		1,2	X8910404-1L	\$144
<input type="checkbox"/> Hip Supports, Right (Ea.)		3	X8910404-2R	\$144
<input type="checkbox"/> Hip Supports, Left (Ea.)		3	X8910404-2L	\$144
<input type="checkbox"/> Hip Supports, Right (Ea.)		4	X8910404-3R	\$144
<input type="checkbox"/> Hip Supports, Left (Ea.)		4	X8910404-3L	\$144

<input type="checkbox"/> Hip Support w/ PU Pad **, ●●	7½" x 3.3" x 1.4"	4	8910404-44	\$788
<input type="checkbox"/> Hip Support w/ PU Pad **, ●●	3¼" x 7½"	4	8910404-45	\$788

**Single Rod Armrest (8910619) required

●●Custom order; Approx. lead time: 6-8 weeks.

The following armrest are height, depth and angle adjustable

<input type="checkbox"/> Armrest w/ Cover (Pr.)	3" x 9" x 9"	1	8910615-2	\$416
<input type="checkbox"/> Armrest w/ Cover (Pr.)	3" x 10" x 11"	2	8910616-2	\$416
<input type="checkbox"/> Armrest w/ Cover (Pr.)	3" x 11¼" x 12¾"	3	8910617-2	\$416
<input type="checkbox"/> Armrest, Dual Post (Pr.)	3" x 14½" x 11¼"	4	8910618	\$416
<input type="checkbox"/> Armrest, Single Post (Pr.)	3" x 14½" x 11¼"	4	8910619	\$416

Armrest distance from seat to top of the armrest

Size 1	Size 2	Size 3	Size 4		
2½ to 5¼"	3½" to 6¼"	5¾" to 9½"	7½" to 12½"		
<input type="checkbox"/> Arm Pads, Mounts on Top of Tray ♦				1,2,3	8910730 \$416
				♦ n/a on size 4 tray	
<input type="checkbox"/> Armrest Holder Kit				One Size	8910613 \$61
<input type="checkbox"/> Daily Adjustment Kit				One Size	8910615-11 \$40

Accessories	Description	Measurements	Size	Part No.	CAD Price
-------------	-------------	--------------	------	----------	-----------

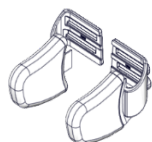

The following laterals are height and width adjustable

- Fixed Side Supports w/ Cover, Type 1 One Size 8910301-1
- Fixed Lateral, Type 1, Right 4 1/4" x 2 3/4" One Size x8910301-1L \$144
- Fixed Lateral, Type 1, Left 4 1/4" x 2 3/4" One Size x8910301-1R \$144

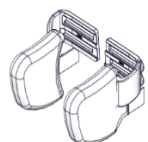

- Fixed Side Supports w/ Cover, Type 2 One Size 8910301-2
- Fixed Lateral, Type 2, Right 4" x 4" One Size x8910301-2L \$144
- Fixed Lateral, Type 2, Left 4" x 4" One Size x8910301-2R \$144

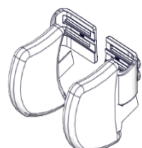

- Fixed Side Supports w/ Cover, Type 3 One Size 8910301-3
- Fixed Lateral, Type 3, Right 4 1/2" x 5 1/2" One Size x8910301-3L \$144
- Fixed Lateral, Type 3, Left 4 1/2" x 5 1/2" One Size x8910301-3R \$144

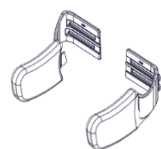

- Fixed Side Supports w/ Cover, Type 4 One Size 8910301-4
- Fixed Lateral, Type 4, Right 6" x 3 1/2" One Size x8910301-4L \$144
- Fixed Lateral, Type 4, Left 6" x 3 1/2" One Size x8910301-4R \$144

••Custom order; Approx. lead time: 6-8 weeks.

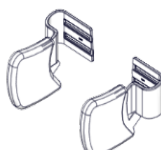

- Fixed Side Supports w/ Cover, Type 5 •• One Size 8910301-5
- Fixed Lateral, Type 5, Right 6 1/4" x 5 3/4" One Size x8910301-5L \$144
- Fixed Lateral, Type 5, Left 6 1/4" x 5 3/4" One Size x8910301-5R \$144

••Custom order; Approx. lead time: 6-8 weeks.

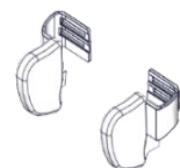

- Fixed Side Supports w/ Cover, Type 6 One Size 8910301-6
- Fixed Lateral, Type 6, Right 4 1/2" x 5 1/2" One Size x8910301-6L \$144
- Fixed Lateral, Type 6, Left 4 1/2" x 5 1/2" One Size x8910301-6R \$144

Width Between Laterals

Pad Type 1-4		Min.	Max	Pad Type 5-6		Min.
Back Size	1	6"	10 1/2"	Back Size	1	4"
	2	8"	12 1/2"		2	6"
	3	10"	14 1/2"		3	8"
Extended	4	12"	16 1/2"	Extended	4	10"

Description	Measurements	Size	Part No.	CAD Price
-------------	--------------	------	----------	-----------

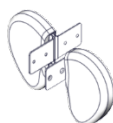

- Fixed Upper Arm Sup. w/Cover** 5" x 4" Type 1 8910407-11 \$111
- Fixed Upper Arm Sup. w/Cover** 7 1/2" x 4 3/4" Type 2 8910407-22 \$133

**Fixed lateral supports required for use



- Snap Locks for Side Supports, Fits Type 1-4, 6 •• 1,2,3,4,6 8910702-30 \$140
- Snap Locks for Side Supports, Fits Type 5 •• 5 8910702-40 \$140

••Custom order; Approx. lead time: 6-8 weeks.



- Swing-Away Lateral Support Bracket, Right (Ea.) One Size 83900-R \$326
- Swing-Away Lateral Support Bracket, Left (Ea.) One Size 83900-L \$326



- Bar, Straight (Ea.) 4 3/4" One Size 81932 \$0
- Bar, Straight, Stainless (Ea.) 3 3/4" One Size 82569 \$0



- Bar, Offset, 1" (Ea.) 4 3/4" One Size 81968 \$0
- Bar, Offset, 1 3/4" (Ea.) 4 3/4" One Size 82000 \$0
- Bar, Offset, 2 1/2" (Ea.) 4 3/4" One Size 81969 \$0

Accessories	Description	Measurements	Size	Part No.	CAD Price
	<input type="checkbox"/> Curved Cushion (Ea.)	3½" x 7½"	One Size	6175406	\$152
	<input type="checkbox"/> Curved Cushion (Ea.)	2½" x 6¾"	One Size	6175405	\$152
	<input type="checkbox"/> Curved Cushion (Ea.)	2½" x 6"	One Size	6175404	\$152
	<input type="checkbox"/> Standard Cushion (Ea.)	6" x 4¾"	One Size	6175403	\$152
	<input type="checkbox"/> Standard Cushion (Ea.)	4" x 4"	One Size	6175402	\$152
	<input type="checkbox"/> Standard Cushion (Ea.)	2⅔" x 4½"	One Size	6175401	\$152

Width Between Laterals with Straight Bar

Back Size	Minimum	Maximum
1	8¾"	13"
2	10¾"	15"
3	12¾"	17"
4 (Extended)	14¾" (16¾")	19" (21")

<input type="checkbox"/> Protective Cushion for Laterals, Black (Ea.)		One Size	89150	\$133
<input type="checkbox"/> Belt for Lateral Pads ●●	10"	One Size	84120-25	\$67
<input type="checkbox"/> Belt for Lateral Pads ●●	16"	One Size	84120-40	\$67

●●Custom order; Approx. lead time: 6-8 weeks.

Description	Measurements	Size	Part No.	CAD Price
-------------	--------------	------	----------	-----------



<input type="checkbox"/> Torso Vest (Ea.)	S-P: 7¾-10¾"	XS	85705-XS	\$289
<input type="checkbox"/> Torso Vest (Ea.)	S-P: 10¾-12½"	S	85705-S	\$289
<input type="checkbox"/> Torso Vest (Ea.)	S-P: 12½-16"	M	85705-M	\$289
<input type="checkbox"/> Torso Vest (Ea.)	S-P: 16-18½"	L	85705-L	\$289
<input type="checkbox"/> Torso Vest (Ea.)	S-P: 18½-20½"	XL	85705-XL	\$289
<input type="checkbox"/> Torso Vest (Ea.)	S-P: 20½-23½"	XXL	85705-XXL	\$289



<input type="checkbox"/> Cross Vest (Ea.)	S-P: 7¾-12½"	XS	85720-XS	\$274
<input type="checkbox"/> Cross Vest (Ea.)	S-P: 10¼-13½"	S	85720-S	\$274
<input type="checkbox"/> Cross Vest (Ea.)	S-P: 13½-17¾"	M	85720-M	\$274
<input type="checkbox"/> Cross Vest (Ea.)	S-P: 17¾-20¾"	L	85720-L	\$274
<input type="checkbox"/> Cross Vest (Ea.)	S-P: 20¾-24½"	XL	85720-XL	\$274

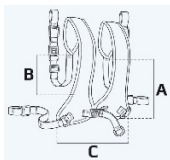

<input type="checkbox"/> Chest Belt, Upholstered (Ea.)	A:11¼xB:7½xC:9¼-12"	1	85428-1	\$390
<input type="checkbox"/> Chest Belt, Upholstered (Ea.)	A:14xB:10xC:10-12¾"	2	85428-2	\$390
<input type="checkbox"/> Chest Belt, Upholstered (Ea.)	A:16½xB:12½xC:10-13"	3	85428-3	\$390



<input type="checkbox"/> 4-Point Padded Hip Belt, 1"	H-H: 6¾-12½"	XS	85725-XS	\$194
<input type="checkbox"/> 4-Point Padded Hip Belt, 1"	H-H: 8¼-13¾"	S	85725-S	\$194
<input type="checkbox"/> 4-Point Padded Hip Belt, 1"	H-H: 9¾-16¼"	M	85725-M	\$194
<input type="checkbox"/> 4-Point Padded Hip Belt, 1"	H-H: 12½-17¼"	L	85725-L	\$194
<input type="checkbox"/> 4-Point Padded Hip Belt, 1"	H-H: 16¼-20½"	XL	85725-XL	\$194

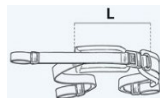



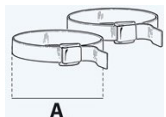

<input type="checkbox"/> 2-Point Pelvic Belt, Black	L: 13-14½"	1	85424-1	\$140
---	------------	---	---------	-------



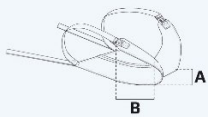

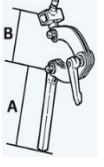
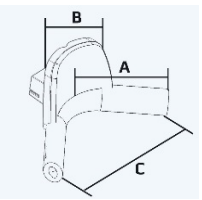



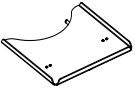

<input type="checkbox"/> Foot Straps, Plastic Lock (Pr.)	Max: 22", A: 13½-20½"	One Size	85096	\$52
<input type="checkbox"/> Foot Straps, Velcro (Pr.)		One Size	85102	\$73

Other types of vests and belts available, please see Vest and Belts Order Form

Accessories	Description	Measurements	Size	Part No.	CAD Price
	<input type="checkbox"/> Pelvic Harness	A: 6½ x B:7½"	0	89108-0	\$442
	<input type="checkbox"/> Pelvic Harness	A: 8½ x B:8¾"	1	89108-1	\$442
	<input type="checkbox"/> Pelvic Harness	A: 10½ x B:9¾"	2	89108-2	\$442
	<input type="checkbox"/> Ankle Straps	C: 6¼-9"	1	85745-XS	\$268
	<input type="checkbox"/> Ankle Straps	C: 9-12¼"	2	85745-M	\$268
	<input type="checkbox"/> Ankle Straps	C: 11½-15"	3	85745-XL	\$268
	<input type="checkbox"/> Formed Footplates (Pr.) ♦	L: 8½"	1, 2	86147	\$239
	<input type="checkbox"/> Formed Footplates (Pr.) ♦	L: 9¼"	3, 4	86148	\$239
♦Footplate will need drilling by supplier once position is set					
Description		Measurements	Size	Part No.	CAD Price
Swing-away Mounting Brackets - Height, Depth, Angle and Lateral Adjustable					
	<input type="checkbox"/> Turtle Bar System ♦	A: 5", B: 4-8½"	Short	98619-25	\$332
	<input type="checkbox"/> Turtle Bar System ♦	A: 10", B: 4-8½"	Long	98619-26	\$332
♦Required with Anatomic Head Support; 5099001, 5099002 or 5099003					
	<input type="checkbox"/> Anatomic Head Support ♦	A:5½ x B:5½ x C:9½"	Small	5099001	\$369
	<input type="checkbox"/> Head Support Cover (Required)		Small	9923-83	\$0
	<input type="checkbox"/> Anatomic Head Support ♦	A:6 x B:5½ x C:10"	Medium	5099002	\$460
	<input type="checkbox"/> Head Support Cover (Required)		Medium	9945-83	\$0
	<input type="checkbox"/> Anatomic Head Support ♦	A:6½ x B:5½ x C:12½"	Large	5099003	\$460
	<input type="checkbox"/> Head Support Cover (Required)		Large	9967-83	\$0
♦Turtle Bar System Short or Long Required; 98619-25 or 98619-26					
XX = Turtle Bar Size					
<input type="checkbox"/> 92 = Short Turtle Bar		<input type="checkbox"/> 93 = Long Turtle Bar			
	Adjustable Headrest without Dynamic Feature - Requires Bracket (see below)				
	<input type="checkbox"/> Adj. Width Headrest, Large Laterals, Black Cover ♦			99737xx-85	\$550
<input type="checkbox"/> Adj. Width Headrest, Large Laterals, w/Speakers, Black Cover ♦♦			99717xx-85	\$730	
♦♦Custom order; Approx. lead time: 6-8 weeks.					
♦Turtle Bar System Short or Long Required; x98619-25 or x98619-26					
	Adjustable Headrest with Dynamic Feature - Requires Bracket (see below)				
	<input type="checkbox"/> Adj. Width Headrest, Large Laterals, Black Cover ♦			99736xx-85	\$693
<input type="checkbox"/> Adj. Width Headrest, Large Laterals, w/Speakers, Black Cover ♦♦			99756xx-85	\$693	
♦♦Custom order; Approx. lead time: 6-8 weeks.					
♦Turtle Bar System Short or Long Required; x98619-25 or x98619-26					
<input type="checkbox"/> Headband System for Anatomic Head Support Only			One Size	99500	\$332
<input type="checkbox"/> Universal Headrest Mount ♦			One Size	87590	\$88
♦Required when using other manufactures Head Support					
Allows most Whitmyer, Stealth, Otto Bock headrest, I2I to mount to our products (x:panda, Serval, etc.). Please contact Customer Service for confirmation					

Other types of headrest available, please see Head Supports Order Form

Accessories	Description	Measurements	Size	Part No.	CAD Price
All trays require armrest					
	<input type="checkbox"/> Tray, Grey (Ea.) ••		1,2	8910720-1	\$167
	<input type="checkbox"/> Swing-Away Removable Hardware (Ea.) (Required)		1,2	X8910720-12	\$274
	<input type="checkbox"/> Tray, Grey (Ea.) ••		3,4	8910720-2	\$167
	<input type="checkbox"/> Swing-Away Removable Hardware (Ea.) (Required)		3,4	X8910720-22	\$274
••Custom order; Approx. lead time: 6-8 weeks.					
	<input type="checkbox"/> Tray, Two-Rod System, Grey (Ea.)		1,2	8910725-1	\$167
	<input type="checkbox"/> Swing-Away Removable Hardware (Ea.) (Required)		1,2	X8910725-12	\$274
	<input type="checkbox"/> Tray, Two-Rod System, Grey (Ea.)		2,3	8910725-2	\$167
	<input type="checkbox"/> Swing-Away Removable Hardware (Ea.) (Required)		2,3	X8910725-22	\$274
	<input type="checkbox"/> Tray, Two-Rod System, Grey (Ea.)		4	8910725-3	\$167
	<input type="checkbox"/> Swing-Away Removable Hardware (Ea.) (Required)		4	X8910725-32	\$274
	<input type="checkbox"/> Tray, Plastic, Grey		1,2	8976350	\$326
	<input type="checkbox"/> Toy Bar for Tray ◆ n/a on size 4 tray		1,2,3	8910740	\$326
	<input type="checkbox"/> Grip Handle for Tray ◆, •• ◆ Does not work on size 4 x:panda ••Custom order; Approx. lead time: 6-8 weeks. Non-returnable item		1,2,3	8910750	\$580
	<input type="checkbox"/> Activity Center ◆, •• ◆ Does not work on size 4 x:panda ••Custom order; Approx. lead time: 6-8 weeks. Non-returnable item		1,2,3	89250	\$1,158
	<input type="checkbox"/> x:panda Canopy- Attaches to Seat ◆ ◆ For size 1 and 2 x:panda only		One Size	SN67-9901	\$202
	<input type="checkbox"/> Stingray Canopy, Black fits x:panda size 1 & 2		1	8740110	\$477
	<input type="checkbox"/> Stingray Canopy, Black fits x:panda size 3 & 4		2	8740120	\$477
	<input type="checkbox"/> Holders for Stingray Canopy** **Required when ordering Stingray Canopy		One Size	9589100	\$67

x:panda on High-Low Frames →When selecting the x:panda on a High-Low:x base, suggested HCPCS do not apply

Indoor Models

Manual Lift

- High-Low:xo Indoor sz 1* 6 3/4" - 23 1/4" 154 lbs max 1,2 89010522 \$2,631
- High-Low:xo Indoor sz 2* 8 1/2" - 23 1/2" 165 lbs max 3 89020522 \$2,823
- High-Low:xo Indoor sz 3♦* 11 3/4" - 21 1/4" 220 lbs max 4 89020522 \$2,823

*Requires Push Brace (890009-04 or 8910555)

Power Lift

- High-Low:xo Indoor sz 1●●* 6 3/4" - 22 3/4" 154 lbs max 1,2 89010532 \$4,228
- High-Low:xo Indoor sz 2●●* 8 1/4" - 22 3/4" 165 lbs max 3 89020532 \$4,539
- High-Low:xo Indoor sz 3♦* 10 3/4" - 20 3/4" 209 lbs max 4 89030532 \$4,938

♦Adapter not included on Power or Manual Indoor sz 3

●●Custom order; Approx. lead time: 6-8 weeks. Non-returnable item

*Requires Push Brace (890009-04 or 8910555)

- Adaptor for x:panda sz 4 on High-Low:xo 3 ♦ 4 8911610-99 \$316
- ♦Required when ordering High-Low:x sz 3 (8911607-02ELUS)

- Anti-Tip for Indoor High-Low:xo Indoor One Size 890007 \$238

- Push Brace - Fixed Angle One Size 890009-04 \$261

- Push Brace - Angle Adjustable; n/a on x:panda sz 4 1,2,3 8910555 \$557

Outdoor Models

Manual Lift

- High-Low:xo Outdoor sz 1, Manual Lift - for x:panda sz 1 & 2 1,2 89110152 \$4,433
- High-Low:xo Outdoor sz 2, Manual Lift - for x:panda sz 3 3 89120152 \$4,988

●●Custom order; Approx. lead time: 6-8 weeks. Non-returnable item

Power Lift

- High-Low:xo Outdoor sz 1, Power Lift - for x:panda sz 1 & 2 ●● 1,2 89110132 \$5,241
- High-Low:xo Outdoor sz 2, Power Lift - for x:panda sz 3 ●● 3 89120132 \$5,624

●●Custom order; Approx. lead time: 6-8 weeks. Non-returnable item

High-Low:x Outdoor frame not available for x:panda size 4.

- Anti-Tip for High-Low:xo Outdoor One Size 890008 \$319
- Custom order; Approx. lead time: 6-8 weeks.

- Transit Option for High-Low Outdoor Frame (Set) One Size 890005 \$319

x:panda on Stingray Frame

- Stingray Tilt-In-Space - for x:panda sz 1 & 2 (Individual Wheel Locks) One Size 8702212-XP \$4,270
- For use with x:panda size 1 (S,M,L) x:panda size 2 (S,M)**

- Stingray Tilt-In-Space - for x:panda sz 1 & 2** (Central Wheel Locks) One Size 8702222-XP \$4,913
- **Required if using Vent Tray
For use with x:panda size 1 (S,M,L) x:panda size 2 (S,M)

- Transit Option for Stingray (Set) One Size 8720902 \$290

- O2 Tank Holder *●● 8776295 \$506
- *Transit Option (9720902) is required
●●Custom order, Approx. lead time: 6-8 weeks. Non-returnable item

- Medical Essential Carrier One Size 8720600 \$140

- Vent Tray ♦* One Size 8776290 \$659
- ♦ Requires Central Wheel Locks
*44 lbs. weight capacity

- IV Pole, Height Adjustable and Collapsible One Size C904566 \$290

- IV Pole Holder** 8776291 \$202
- **Required if using IV Pole

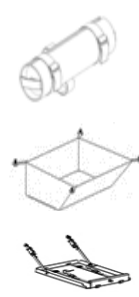
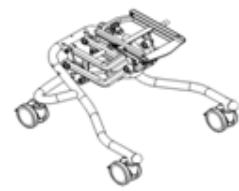



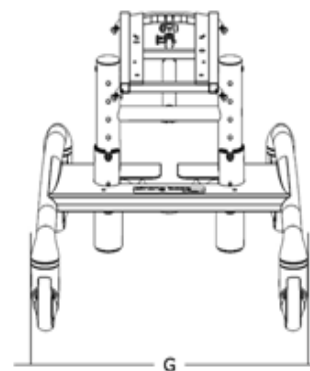
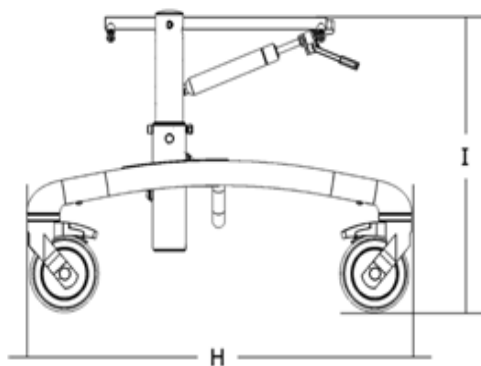

R82 Strong Base for x:panda sz 4

CAD Retail Price List/ Order Form

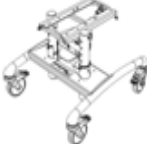

	Strong Base Manual adj. Inches	Strong Base Spindle adj. Inches
Frame width (G)	23½"	23½"
Frame length (H)	27¼"	27¼"
Height (I)	11¾-21¾"	11¾-21¾"
Top of x:panda 4 seat to floor	16½-26½"	16½-26½"
Top of Panda 5 seat to floor	17¾-27½"	17¾-27½"
Angling of base plate	-10 - +25°	-10 - +25°
Weight	31 lbs.	34¼ lbs.
Max. load	264 lbs.	264 lbs.

Mobility Bases	Description	Measurements	Size	Part No.	CAD Price
	<input type="checkbox"/> Strong Base, Manual Lift - for x:panda sz 4 ●● ●●Custom order; Approx. lead time: 6-8 weeks. Non-returnable item		One Size	89508-1M	\$2,471
	<input type="checkbox"/> Strong Base with Spindle - for x:panda sz 4 ●● ●●Custom order; Approx. lead time: 6-8 weeks. Non-returnable item		One Size	89508-1S	\$2,797
	<input type="checkbox"/> Adapter for Strong Base (Required) ●●Custom order; Approx. lead time: 6-8 weeks. Non-returnable item		One Size	8911610-99L	\$289
	<input type="checkbox"/> Push Brace - Fixed Angle		One Size	8910545	\$229
	<input type="checkbox"/> Angle Adjustable Push Brace, Long		One Size	8910565	\$427

R82 Multi Frame

CAD Retail Price List/ Order Form

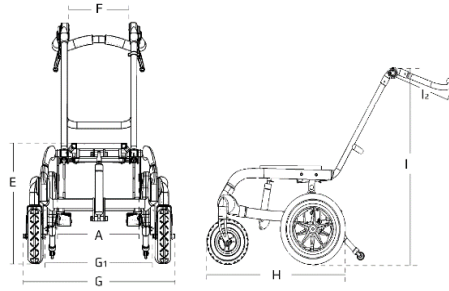

	Size 1 Inches	Size 2 Inches	Size 3 Inches
Width, inside (A)	13½"	15¼"	17¼"
Height floor to basic plate (E) (top/mid/bottom pos.)	15½/16¾/18"	15½/16¾/18"	15½/16¾/18"
Back width, inside (F)	9¾"	11½"	13½"
Overall width 12½" (G)	23¼"	25¼"	27¼"
Overall width 22" (G)	23¼"	25¼"	27¼"
Distance between wheels w/drum brakes (G1)	17"	19"	20¾"
Distance between wheels wo/drum brakes (G1)	17¼"	19¼"	21¼"
Length, with 12½" (22") wheels (H)	25¼" (29½")	25¼" (29½")	27¼" (31½")
Overall height push brace 15° (I)	36"	36"	36"
Overall height push brace 30° (I)	33½"	33½"	33½"
Push brace length (I2)	8¾"	8¾"	8¾"
Folded height, w/ 12½" (22") back wheels (mid position)	18½" (22")	18½" (22")	18½" (22")
Folded length, with 12½" (22")	28¾" (33½")	28¾" (33½")	30¾" (35½")
Max load	220.4 lbs.	220.4 lbs.	220.4 lbs.



- HCPCS**
- Size 1 E1233
 - Size 2 E1233
 - Size 3 E1161
 - Silver
 - 12½" air, black, incl. wheel brake
 - 22" air, grey, incl. wheel brake
 - 12½" solid, black, incl. wheel brake
 - 22" solid, grey, incl. wheel brake
 - Standard brake - see above
 - Drum Brake for 12½" - *Upcharge*
 - Drum brake for 22" - *Upcharge*
 - 7" x 2" Pneumatic Caster Tires
 - 7" x 2" Solid Caster Tires
 - Gradual back angling
 - Gradual back angling, w/ additional dept

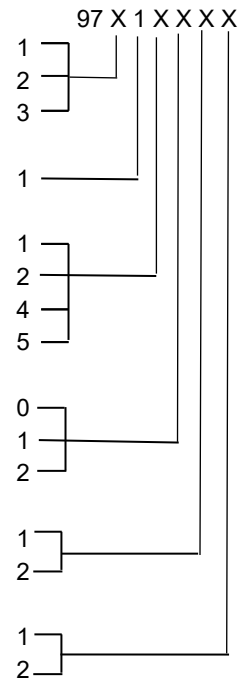

Description	Measurements	Size	Part No.	CAD Price
<input type="checkbox"/> Wheelchair Frame with 12½" Rear Wheels		97x140x10	973110210	\$4,162
<input type="checkbox"/> Wheelchair Frame with 22" Rear Wheels		97x150x10	973120210	\$4,263
<input type="checkbox"/> Drum Brakes, 12½" or 22" Rear Wheels (Upcharge)				\$398

Most Common Configuration:

- Multi Frame sz 3, Silver, 7x2", 12½" Solid Tire, Std. Wheel Locks 973140210 \$4,234

••All other configurations are a custom order; Approx. lead time: 6-8 weeks. Non-returnable item

Accessories	Description	Measurements	Size	Part No.	CAD Price
-------------	-------------	--------------	------	----------	-----------

Adaptor is required for x:panda size 1, 2 & 3. The x:panda size 3 can also be permanently mounted on the Multi Frame without an adaptor.



- Adaptor for x:panda on Multi Frame - for x:panda sz 1, 2 & 3 8911610-98 \$316
- Adaptor for x:panda on Multi Frame sz 3 - for x:panda sz 4 ♦ 8911610-99 \$316

♦ **Adaptor is required on x:panda sz 4**

- Anti-Tips 970957 \$216
- Transit Option for Multi Frame 970905 \$360



- Vent Tray for Multi Frame sz 2 & 3 ●● 970815 \$811

●● **Custom order; Approx. lead time: 6-8 weeks.**

Description	Measurements	Part No.	CAD Price
-------------	--------------	----------	-----------

The following Foot Support options are for the High-Low:x, Strong Base, Stingray, Multi Frame & Multi Frame:x



- Footplate, Angle & Height Adj. 12" x 7½" 95145-1 \$208
- Footplate, Angle & Height Adj. 14" x 9" 85145-2 \$208



- Footplate, Angle & Height Adj. ♦ 14" x 9" 95145-2 \$208
- Footplate, Angle & Height Adj. ♦ 16" x 9½" 95145-3 \$208
- Footplate, Angle & Height Adj. ♦ 18¾" x 9½" 95145-4 \$208

♦ **Includes 4" mounting fitting**



- Mounting for footplate, for higher fitting** 85135 \$107

****To be used with 8910821-x**

Footplates must include a mounting bar below



- Elevating Footplate Mounting Bar 6" - 10½" 8910821-1 \$261
- Elevating Footplate Mounting Bar 6" - 14½" 8910821-2 \$261
- Elevating Footplate Mounting Bar 6" - 17" 8910821-3 \$261

Description	Measurements	Part No.	CAD Price
-------------	--------------	----------	-----------



- Multi Adj. Foot Support ●● 6" - 10½" 8910852-1 \$730
- Multi Adj. Foot Support ●● 6" - 14½" 8910852-2 \$730
- Multi Adj. Foot Support ●● 6" - 17" 8910852-3 \$730

●● **Custom order; Approx. lead time: 6-8 weeks.**



- Width Extension - Multi-Adj. Foot Support ●● 8910855 \$139

●● **Custom order; Approx. lead time: 6-8 weeks. Non-returnable item**

Description	Measurements	Part No.	CAD Price
-------------	--------------	----------	-----------



- Individual Foot Supports (Pr.) ●● 7" x 3" 89143-1 \$730
- Individual Foot Supports (Pr.) ●● 8½" x 3½" 89143-2 \$730
- Individual Foot Supports (Pr.) ●● 9½" x 4½" 89143-3 \$730

●● **Custom order; Approx. lead time: 6-8 weeks.**



- Dual Elevating Footplate Mount Bar 6" - 10½" 8910841-1 \$261
- Dual Elevating Footplate Mount Bar 6" - 14½" 8910841-2 \$261
- Dual Elevating Footplate Mount Bar 6" - 17" 8910841-3 \$261

●● **Custom order; Approx. lead time: 6-8 weeks.**

HCPSC codes are provided for your convenience and are NOT to be considered billing or legal advice. Providers are responsible for insuring that all appropriate billing codes are used when submitting claims. Proper use of HCPSC codes does not insure coverage or payment. Contact the appropriate payer for coverage information.

Prices in CAD & is subject to change without notice

For Quotes and Orders please send completed Order Form to: sales.us@etac.com or Fax: 1-800-760-0537

OF6702-ENG-REV.09

Etac
13137 Bleinheim Lane
Matthews, North Carolina 28105

