

R82 Heron

USD Retail Price List/ Order Form

Account #: _____ Purchase Order No.: _____ Date: _____
 Contact: _____ Mark For: _____

Bill To:	Ship To:
Address:	Address:
City/State/Zip:	
Phone:	City/State/Zip:
Email	Phone:

US Configuration

Effective: 01.10.24 - Rev 5

- Heron
- Head support
- Back support
- Swing away side support
- Arm rest/tray
- Foot and hip supports
- Commode pan
- Splash guard
- Vests and belts



- A** (Back height) _____
- B** (Arm height) _____
- C** (Lower leg length) _____
- D** (Seat depth) _____
- E** (Chest width) _____
- F** (Seat width) _____
- G** (Height from seat to top of head) _____
- H** (Shoulder width) _____
- Age _____
- Weight _____

Measurements

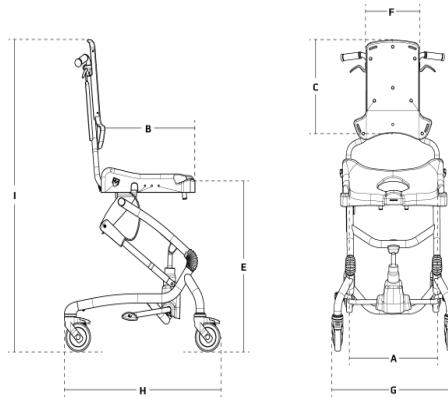

Heron

Seat width (A)	21¾"
Seat width with hip supports (accessories)	13¾"-19¼"
Seat depth (B)	17¾"
Seat depth with reduction kit (accessories)	15¾"
Back height (C)	21¾"-24½"
Lower leg length (D)	15¾"-22"
Seat height above floor (E)	20-30¾"
Back width (F)	11½"
Width, frame (G)	26½"
Length, frame (H)	28"
Height, frame w/seat (I)	42½"-53¼"
Seat angling (tilt in space)	-5° to +25°
Back angling	90° to +120°
Weight, without arm rests	61.5 lbs.
Max. Load/user weight	220.4 lbs.

Heron Standard Features

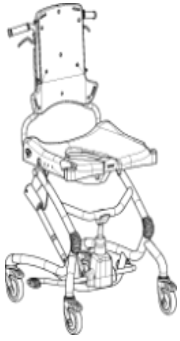

- One size
- 4 grey castors with locks
- Stainless steel frame
- Height adjustable frame
- Integrated push handles
- Built-in tilt in space
- Built-in recline
- Active, height adjustable back
- Potty ring

Description	Size	Part No.	USD Price
<input type="checkbox"/> Heron	One Size	880505-01	\$5,615

Accessories	Description	Measurements	Size	Part No.	USD Price
-------------	-------------	--------------	------	----------	-----------

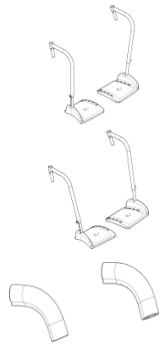

<input type="checkbox"/> Foot Support, Right-Angled Knee (Pr.) <i>(lower leg range: 15 1/2"-22")</i>	One Size	880506-01	\$529
<input type="checkbox"/> Foot Support, Open Knee Angle (Pr.) <i>(lower leg range: 15 1/2"-22")</i>	One Size	880506-02	\$529
<input type="checkbox"/> Padding for Foot Supports (Pr.)	One Size	880506-12	\$70

Description	Size	Part No.	USD Price
-------------	------	----------	-----------

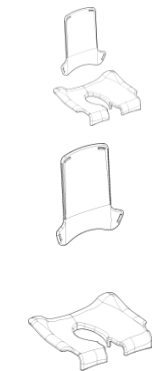

<input type="checkbox"/> Upholstery, Complete (Set)	One Size	880507-01	\$315
<input type="checkbox"/> Upholstery, Back Only (Ea.)	One Size	101204	\$156
<input type="checkbox"/> Upholstery, Seat Only (Ea.)	One Size	117005	\$173

Description	Size	Part No.	USD Price
-------------	------	----------	-----------



<input type="checkbox"/> Armrest, Swing-Away (Pr.)	2 x 14 1/2 x 9 3/4"	One Size	880508-03	\$519
--	---------------------	----------	-----------	-------

Description	Size	Part No.	USD Price
-------------	------	----------	-----------

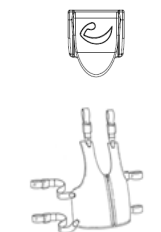

<input type="checkbox"/> Fix-Locks, White, Bag of 4 Pcs ** **Required for use of Vests	One Size	890505-36	\$45
<input type="checkbox"/> Vest	3	89111-340	\$214
<input type="checkbox"/> Vest	4	89111-440	\$214
<input type="checkbox"/> Neoprene Hip-Belt	2	85423-2	\$104

Accessories	Description	Measurements	Size	Part No.	USD Price
-------------	-------------	--------------	------	----------	-----------



Sides/Wings (Pr.) 4 x 14" One Size 880508-01 \$91



Upholstery for Sides/Wings (Pr.) 4 x 14" One Size 880507-04 \$91

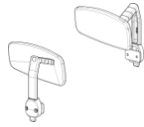

Hip Supports (Pr.) 8¼"W x 4"H One Size 880508-02 \$337
(seat width range: 13 ½"-22")

Description	Measurements	Size	Part No.	USD Price	HCPCS
-------------	--------------	------	----------	-----------	-------

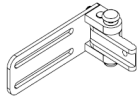

Swing-Away Bracket, Stainless, Right (Ea.) One Size 83000-R \$241 E1028

Swing-Away Bracket, Stainless, Left (Ea.) One Size 83000-L \$241 E1028



Bar, Straight, Stainless (Ea.) 6¼" One Size 82648 \$0 E1028

Bar, Offset, 1" Stainless, (Ea.) 4¾" One Size 150238 \$0 E1028

Cushion, Curved (Ea.) 3½ x 7½" One Size 6175407 \$113 E0956

Cushion, Curved (Ea.) 2½ x 6½" One Size 6175408 \$113 E0956

Cushion, Curved (Ea.) 2½ x 5¾" One Size 6175409 \$113 E0956

Protection Pads (Ea.) One Size 89151 \$98

Description	Measurements	Size	Part No.	USD Price	HCPCS
-------------	--------------	------	----------	-----------	-------

Headrest 2, Grey One Size 6172000 \$219 E0955

Headrest 3, Grey One Size 6173000 \$219 E0955

Headrest 4, Grey One Size 6174000 \$219 E0955

Swing-away Mounting Brackets - Height, Depth, Angle and Lateral Adjustable

Stainless Turtle Bar System One Size 98619-24 \$246 E0955

Stainless Bar System, Straight •• 9" One Size 87583 \$246 E0955

Stainless Bar System, Straight •• 14½" One Size 87585 \$246 E0955

Stainless Swan Neck •• 7½ x 4" One Size 87580 \$214 E0955

Stainless Swan Neck •• 13½ x 7¾" One Size 87582 \$262 E0955

••Custom order; Approx. lead time: 6-8 weeks.

Description	Measurements	Size	Part No.	USD Price
-------------	--------------	------	----------	-----------



Tray; Mounted in Armrest 17¼ x 7½" One Size 880508-04 \$337

Description	Measurements	Size	Part No.	USD Price
-------------	--------------	------	----------	-----------



Commode Pan 7¾ x 13½ x 4¾" One Size 880130 \$54

Lid for Commode Pan One Size 880130-L \$70





Splash Guard 3 x 5¼" One Size 880508-05 \$75

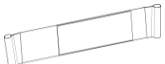
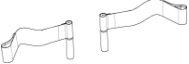

Splash Guard, Low •• One Size 880508-07 \$69

••Custom order; Approx. lead time: 6-8 weeks.

Accessories	Description	Measurements	Size	Part No.	USD Price
	<input type="checkbox"/> Calf Support, Strap (Ea.)	4"	One Size	880509-01	\$70
	<input type="checkbox"/> Heel Stops, Straps (Pr.)	1½"	One Size	880509-02	\$128
	<input type="checkbox"/> Shock Absorber, White ●● ●● <i>Custom order; Approx. lead time: 6-8 weeks.</i>		One Size	116924-KIT	\$41

Spare Parts	Description	Measurements	Size	Part No.	USD Price
	<input type="checkbox"/> Potty Ring		One Size	109072	\$46

HCPCS codes are provided for your convenience and are NOT to be considered billing or legal advice. Providers are responsible for insuring that all appropriate billing codes are used when submitting claims. Proper use of HCPCS codes does not insure coverage or payment. Contact the appropriate payer for coverage information.

Prices in USD & is subject to change without notice
For Quotes and Orders please send completed Order Form to: us.info@r82.com

Etac
13137 Bleinheim Lane
Matthews, North Carolina 28105
+1 844-US-MOBILITY (844-876-6245)
www.etac.us.com

OF5500-ENG-REV.05

Creating Possibilities