

R82 Crocodile - E8000

USD Retail Price List/ Order Form

Account #: _____ Purchase Order No.: _____ Date: _____
 Contact: _____ Mark For: _____

Bill To:	Ship To:
Address:	Address:
City/State/Zip:	
Phone:	City/State/Zip:
Email:	Phone:

US Configuration

Effective: 01.01.22 - Rev 5

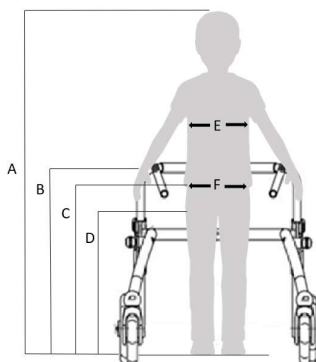

- A (Total Height) _____
- B (Floor to Wrist Height)* _____
- *with arms slightly bent at elbow _____
- C (Top of Pelvis Height) _____
- D (Buttock Height) _____
- E (Chest Width) _____
- F (Pelvis Width) _____
- Age _____
- Weight _____

Measurements

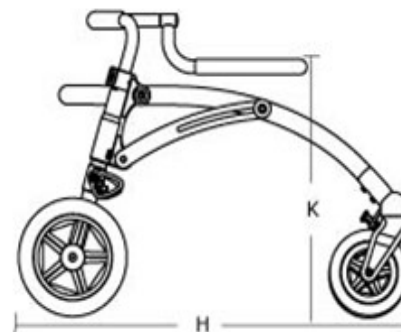
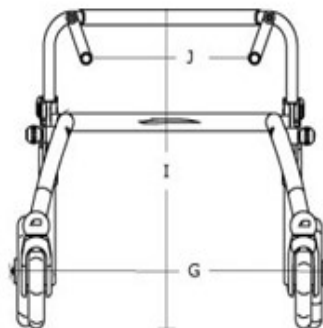

Product Specs

	Starter Kit My First Steps Inches	Size 1 Inches	Size 2 Inches	Size 3 Inches
Width, Between handles (J)	3½-10"	7½-13½"	12½ - 23½"	13½-25¼"
Height, Floor to handles (K)	15 - 27 ½"	16½-28¼"	21¾-33"	29½-41¼"
Width, Max (G)	24½"	24½"	27¼"	27¼"
Length, Standard (H)	26"	28¼"	33"	34¼"
Height - Floor to Top Frame (I)	20½-30"	20½-30"	22¼-33"	32¾-43"
Length, Folded	28"	28"	33½"	39½"
Height, Folded	12"	12"	10½"	11"
Weight, Standard	12 lbs.	12 lbs.	14 lbs.	26½ lbs.
Turning Radius	39¼"	39¼"	45"	45"

User Measurement Guide for Crocodile

User Height, Maximum (A)	42¼"	42¼"	59"	70¾"
User Weight, Maximum	66 lbs.	66 lbs.	99 lbs.	176¼ lbs.

Crocodile Standard Features

Size 1 & 2

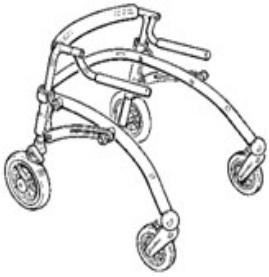



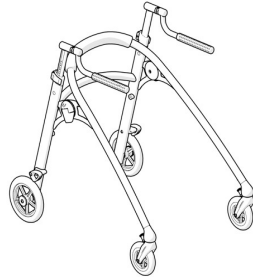







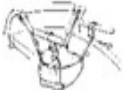

Size 3











- Width & Height Adjustable Rotation Handles
- Easy to Fold
- Lightweight Durable Aluminum Frame (sz 1 and 2)
- Stable Steel & Aluminum Frame (sz 3)
- Upholstery & Cover for Top Frame
- Solid Front & Rear Wheels
- Swivel Front Casters with Castor Locks
- Adjustable Rear Drag Wheels
- On/Off Anti-Reverse Wheel Stop (Prevents Unit from Rolling Backwards)
- Padded Rear Stabilizer Bar with Tool Kit

Description	Size	Part No.	USD Price	HCPCS
<input type="checkbox"/> Crocodile Gait Trainer, Yellow	1	86801	\$772	E8000
<input type="checkbox"/> Crocodile Gait Trainer, Orange	2	86802	\$772	E8000
<input type="checkbox"/> Crocodile Gait Trainer, Black	2	86852	\$772	E8000
<input type="checkbox"/> Crocodile Gait Trainer, Metallic Grey ♦	3	86803	\$1,273	E8000
♦ Crocodile sz 3 requires Cross Bar for Back Support				

Accessories	Description	Measurements	Size	Part No.	USD Price	HCPCS
	<input type="checkbox"/> Starter Kit Hand Brace Assy* ♦ Allows lower handle height & narrower handle width	15" - 27 1/2"	1	86801-0	\$456	
	<input type="checkbox"/> Forearm Support w/Handgrip (Pr.)	L:5 3/4 x W:3"	1	86858	\$386	
	<input type="checkbox"/> Forearm Support w/Handgrip (Pr.)	L:7 x W:4"	2	86859	\$386	
	<input type="checkbox"/> Forearm Support w/Handgrip (Pr.)	L:7 x W:4"	3	86860	\$386	
	<input type="checkbox"/> Padded Forearm Positioner (Ea.)		One Size	869370	\$71	
	<input type="checkbox"/> Pelvic Pad w/Lateral (Ea.) ♦	3 1/2" x 4 3/4" - 9"	Small	86808	\$274	
	<input type="checkbox"/> Pelvic Pad w/Lateral (Ea.) ♦	3 1/2" x 7" - 11 1/2"	Large	86809	\$274	
	♦ Required with Sling Seat Lightweight					
	<input type="checkbox"/> Lateral Strap for Pelvic Pad (Ea.) ♦ ♦ Required with Sling Seat Lightweight		One Size	905011	\$53	
	<input type="checkbox"/> Back Support, Angle and Width Adj. ♦ ♦ Crossbar Required (86880)	9 1/2" - 11 1/2" x 7"	3	86886	\$527	
	<input type="checkbox"/> Back Support Strap, Small (Ea.) ♦	11 1/2" x 3"	3	85490-1	\$91	
	<input type="checkbox"/> Back Support Strap, Large (Ea.) ♦ ♦ For Back Support (86886)	13 1/2" x 4"	3	85490-2	\$91	
	<input type="checkbox"/> Cross Bar for Back Support (Ea.) ♦ ♦ Required with Back Support (86886)		3	86880	\$101	
	<input type="checkbox"/> Sling Seat, Lightweight (Ea.) ♦	23 1/2" (Waist)	1	86824-1	\$140	
	<input type="checkbox"/> Sling Seat, Lightweight (Ea.) ♦ ♦ Requires Pelvic Pad w/ Laterals Small or Large and Lateral Strap	27 1/4" (Waist)	2	86825-1	\$140	

Accessories	Description	Measurements	Size	Part No.	USD Price	HCPCS
	<input type="checkbox"/> Sling Seat (Ea.)	23½" (Waist)	1	86824	\$140	
	<input type="checkbox"/> Sling Seat (Ea.)	27¼" (Waist)	2	86825	\$140	
	<input type="checkbox"/> Solid Seat, Yellow (Ea.)*	11½" (Seat to Floor Height)	1	86820	\$177	
	<input type="checkbox"/> Solid Seat, Orange (Ea.)*	16¾" (Seat to Floor Height)	2	86821	\$177	
	<input type="checkbox"/> Solid Seat, Black (Ea.)*	16¾" (Seat to Floor Height)	2	86823	\$177	
	<input type="checkbox"/> Solid Seat, Metallic Grey (Ea.)*	22" (Seat to Floor Height)	3	86863	\$177	
	*Cannot be used with Starter Kit					
	<input type="checkbox"/> Handle Knobs (Pr.)		All Sizes	86861	\$53	
	<input type="checkbox"/> Anti-Tip Device, Swing-Away (Pr.)		1, 2	86815	\$167	
	<input type="checkbox"/> Anti-Tip Device, Swing-Away (Pr.)		3	86815-3S	\$167	
	<input type="checkbox"/> Anti-Tip Device, Fixed (Pr.)		1, 2	86815-F	\$80	
	<input type="checkbox"/> Anti-Tip Device, Fixed (Pr.)		3	86815-3F	\$80	
	<input type="checkbox"/> Hand Brake*^		1, 2	86834	\$250	
	<input type="checkbox"/> Hand Brake*^		3	86873	\$250	
	* Hand brake eliminates the function of anti-reverse wheel stop					
	* If ordering hand brake with anti-reverse wheel stop function, a custom order required					
	<input type="checkbox"/> Decelerating Hand Brake Kit*^		1, 2	86834-DEC	\$250	
	<input type="checkbox"/> Decelerating Hand Brake Kit*^		3	86873-DEC	\$250	
	* Hand brake eliminates the function of anti-reverse wheel stop					
	* If ordering hand brake with anti-reverse wheel stop function, a custom order required					
	<input type="checkbox"/> Custom, Hand Brake with Anti-reverse Wheel Stop**			8697	Custom	
	** Custom order; Approx. lead time: 6-8 weeks. Non-returnable item					
	^ If mounting vertically on forearm support, a custom order required					
	<input type="checkbox"/> Custom, Hand Brake on Vertical Mount Kit**			9774	Custom	
	** Custom order; Approx. lead time: 6-8 weeks. Non-returnable item					
	<input type="checkbox"/> Attendant Guide Bar (Ea.)		1, 2	86866	\$125	
	<input type="checkbox"/> Storage Bag (Ea.) ♦	7" x 11"	1, 2	86839	\$74	
	<input type="checkbox"/> Storage Bag (Ea.) ♦	11" x 14"	3	86843	\$219	
	♦ Sz 1 & 2 has 6½ lbs. weight limit, sz 3 has a 11 lbs. weight limit					
	<input type="checkbox"/> Cover for Top Frame		1	86813	\$91	
	<input type="checkbox"/> Cover for Top Frame		2	86814	\$91	
	<input type="checkbox"/> Cover for Top Frame		3	86883	\$91	
	<input type="checkbox"/> Handle (Ea.)		1, 2	86833-TD	\$120	
	<input type="checkbox"/> Handle (Ea.)		3	86862	\$115	
	<input type="checkbox"/> Cover for Handle, Version 1-4		1, 2	2500520	\$23	
	<input type="checkbox"/> Cover for Handle, Version 5		1, 2	2500530	\$35	
	<input type="checkbox"/> Cover for Handle		3	2500520	\$23	

Spare Parts	Description	Measurements	Size	Part No.	USD Price	HCPCS
	<input type="checkbox"/> Replacement kit, upgrade to version 5		1	100783-1	\$449	
	<input type="checkbox"/> Replacement kit, upgrade to version 5		2	100783-2	\$449	
	<input type="checkbox"/> Knob for Folding Mechanism (Ea.)		1, 2	3470393	\$22	
	<input type="checkbox"/> Lock Parts for Handle Bar (Pr.)		1, 2	86831	\$16	
	<input type="checkbox"/> Lock Part for Handle and Cross Bar (Ea.)		3	86831-3U	\$22	

Spare Parts	Description	Qty	Size	Part No.	USD Price	HCPCS
	<input type="checkbox"/> On/Off Anti-Reverse Wheel Stop (Pr.)	_____	1, 2	86828	\$50	
	<input type="checkbox"/> On/Off Anti-Reverse Wheel Stop (Pr.)	_____	3	86828-3U	\$48	
 	<input type="checkbox"/> Front Fork, Right	_____	1, 2	86837-H	\$162	
	<input type="checkbox"/> Front Fork, Left	_____	1, 2	86837-V	\$162	
	<input type="checkbox"/> Front Fork, Right	_____	3	86837-3H	\$162	
	<input type="checkbox"/> Front Fork, Left	_____	3	86837-3V	\$162	
	<input type="checkbox"/> Front Wheel, Universal (Ea.)	_____	One Size	86838	\$61	
 	<input type="checkbox"/> Rear Wheel, Right, Complete	_____	1, 2	86835-1HM	\$250	
	<input type="checkbox"/> Rear Wheel, Left, Complete	_____	1, 2	86835-1VM	\$250	
	<input type="checkbox"/> Rear Wheel, Right, Complete	_____	3	86835-2HM	\$250	
	<input type="checkbox"/> Rear Wheel, Left, Complete	_____	3	86835-2VM	\$250	
	<input type="checkbox"/> Rear Wheel	_____	One Size	8000102	\$78	

HCPCS codes are provided for your convenience and are NOT to be considered billing or legal advice. Providers are responsible for insuring that all appropriate billing codes are used when submitting claims. Proper use of HCPCS codes does not insure coverage or payment. Contact the appropriate payer for coverage information.

Prices in USD & is subject to change without notice

For Quotes and Orders please send completed Order Form to: sales.us@etac.com or fax: 1-800-760-0537

Etac
13137 Bleinheim Lane
Matthews, North Carolina 28105
+1 844-US-MOBILITY (844-876-6245)
www.etac.us.com

OF5200-ENG-REV.05

Creating Possibilities