

## Prescription form





Name: \_\_\_\_\_

Reference: \_\_\_\_\_

Standard version is marked with\*

Date: \_\_\_\_\_

The measurements given can vary  $\pm 2\%$ .

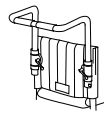
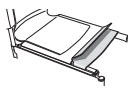
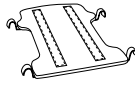
<b>Short frame</b> <b>Seat width (cm)</b> Seat depth adjustable 36-42 cm (Measured from the back support tube)	35	13200101	<input type="checkbox"/>	47,5	13200111	<input type="checkbox"/>
	37,5	13200103	<input type="checkbox"/>	50	13200113	<input type="checkbox"/>
	40	13200105	<input type="checkbox"/>	52,5	13200115	<input type="checkbox"/>
	42,5	13200107	<input type="checkbox"/>	55	13200117	<input type="checkbox"/>
	45	13200109	<input type="checkbox"/>	57,5	13200119	<input type="checkbox"/>
<b>Long frame</b> <b>Seat width (cm)</b> Seat depth adjustable 42-48 cm (Measured from the back support tube)	35	13200102	<input type="checkbox"/>	47,5	13200112	<input type="checkbox"/>
	37,5	13200104	<input type="checkbox"/>	50	13200114	<input type="checkbox"/>
	40	13200106	<input type="checkbox"/>	52,5	13200116	<input type="checkbox"/>
	42,5	13200108	<input type="checkbox"/>	55	13200118	<input type="checkbox"/>
	45	13200110	<input type="checkbox"/>	57,5	13200120	<input type="checkbox"/>
<b>Frame colour</b>	Blueberryblue -48	<input checked="" type="checkbox"/>				
	Grey blaster -53	<input type="checkbox"/>				
<b>Seat angle</b>	Adjustable -3°, 0°, +3°, +5°		Standard = Seat angle +3°		Indicate angle _____°	
<b>Back support</b>	Standard	<input checked="" type="checkbox"/>	Back support high incl. brace	<input type="checkbox"/>	Biangular back incl. brace	<input type="checkbox"/>
	Stepless adjustable 30-45 cm Standard 35 cm Indicate height: _____cm		Stepless adjustable 38-55 cm Standard 45 cm Indicate height: _____cm		Adjustable 38-47 cm Standard 38 cm Indicate height: _____cm	Tapered back support * from 40 cm seat width Stepless adjustable 37-42 cm Standard 37 cm Indicate height: _____cm
<b>Back support height adjustable (cm)</b>						
<b>Back support cover</b>	 Standard dark grey plush	<input checked="" type="checkbox"/>	Standard dark grey plush	<input type="checkbox"/>	Upper back support angle $\pm 15^\circ$ Indicate angle _____°	
	 Comfort	<input type="checkbox"/>	Comfort	<input type="checkbox"/>		
<b>Back support angle</b>	Adjustable -5°-+15°		Standard +2°=92° between back/seat		Indicate angle _____°	
<b>Push handle</b>	Push handle	<input checked="" type="checkbox"/>		Bow handle	<input type="checkbox"/>	
<b>Seat</b>	Seat upholstery, adjustable	<input checked="" type="checkbox"/>		Solid seat	<input type="checkbox"/>	

74512E

27-01-2012

Etac, Box 203, SE-334 24 Anderstorp





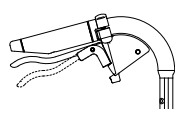
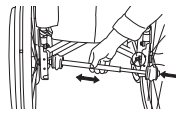

Tel. +46/371-58 73 00, Fax. +46/371-58 73 90





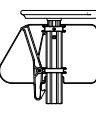
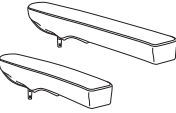
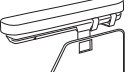

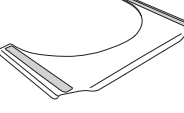



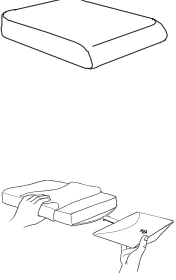

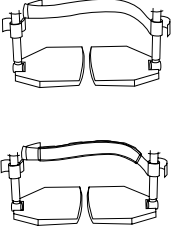
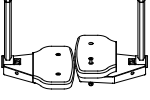

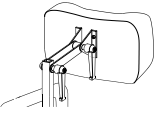





www.etac.com





<p><b>User brake</b></p>	<p>Hub brake</p> <p>Right <input checked="" type="checkbox"/></p> <p>Left <input checked="" type="checkbox"/></p>	<p>High mounted user brake</p> <p>Right <input type="checkbox"/></p> <p>Left <input type="checkbox"/></p>	<p>Brake lever extension</p> <p>Right <input type="checkbox"/></p> <p>Left <input type="checkbox"/></p>	<p>Brake handle angled</p> <p>Right <input type="checkbox"/></p> <p>Left <input type="checkbox"/></p>	<p>Single hand brake</p> <p>Right <input type="checkbox"/></p> <p>Left <input type="checkbox"/></p>
<p><b>Legrest</b> Detachable/swing away With locking device</p>	<p>Standard</p> <p>Ri <input checked="" type="checkbox"/></p> <p>Le <input checked="" type="checkbox"/></p>	<p>Narrow</p> <p>Ri <input type="checkbox"/></p> <p>Le <input type="checkbox"/></p>	<p>Short/Narrow</p> <p>Ri <input type="checkbox"/></p> <p>Le <input type="checkbox"/></p>	<p>Elevating with foldable calf support</p> <p>Ri <input type="checkbox"/></p> <p>Le <input type="checkbox"/></p>	<p>Elevating</p> <p>Ri <input type="checkbox"/></p> <p>Le <input type="checkbox"/></p>
<p><b>Foot support</b></p>	<p>Foldable. Adjustable in depth, angle and height.</p> <p>Tube-standard length <input checked="" type="checkbox"/></p> <p>Tube-short length (-8cm) Only for short/narrow legrest <input type="checkbox"/></p> <p>Tube-long length (+10 cm) <input type="checkbox"/></p>	<p>Foldable. Adjustable in angle.</p> <p>Foot support one piece <input type="checkbox"/></p>			
<p><b>Legrests</b> Others</p>	<p>Amputee support adjustable in height, angle depth and sideway</p> <p>Ri <input type="checkbox"/></p> <p>Le <input type="checkbox"/></p> <p>Plush <input type="checkbox"/></p> <p>Black Dartex <input type="checkbox"/></p>	<p>Amputee weight compensating compl.</p> <p>Ri <input type="checkbox"/></p> <p>Le <input type="checkbox"/></p>	<p>Foot support one-piece children compl. 35/37.5 adjustable in height, depth and angle detachable</p> <p><input type="checkbox"/></p>	<p>Legrest for plaster</p> <p>Ri <input type="checkbox"/></p> <p>Le <input type="checkbox"/></p>	<p>Legrest elevating</p> <p>Ri <input type="checkbox"/></p> <p>Le <input type="checkbox"/></p>
<p><b>Rear wheels</b> with quick release</p>	<p>Pneumatic high pressure 1" <input type="checkbox"/></p> <p>Pneumatic 1 3/8" <input type="checkbox"/></p> <p>Solid <input type="checkbox"/></p>	<p>20" --- <input type="checkbox"/></p> <p>22" <input type="checkbox"/></p> <p>24" <input type="checkbox"/></p>	<p>Assistant brake <input type="checkbox"/></p>		
<p><b>Single-hand drive unit</b> (Only in combination with high mounted user brake)</p>		<p>20" <input type="checkbox"/></p> <p>22" <input type="checkbox"/></p> <p>24" <input type="checkbox"/></p>	<p>Mounted for drive unit</p>	<p>Ri <input type="checkbox"/></p> <p>Le <input type="checkbox"/></p>	<p><input type="checkbox"/></p>



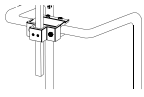
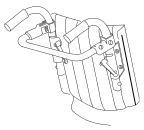
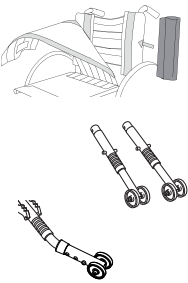

<b>Castors</b>	5" (125x30 mm) solid <input type="checkbox"/>	6" (150x30 mm) solid <input checked="" type="checkbox"/>	7" (175x45 mm) semipneumatic <input type="checkbox"/>
<b>Front seat height</b> (cm) seat tilted backward +3°	<b>Rearwheel</b>	<b>Position</b>	<b>Size</b>
		<b>20"</b>	<b>22"</b> <b>24"</b>
	E	<input type="checkbox"/> 40,0	<input type="checkbox"/> 42,0 <input type="checkbox"/> 44,0
	D	<input type="checkbox"/> 42,5	<input type="checkbox"/> 44,5 <input type="checkbox"/> 46,5
	C	<input type="checkbox"/> 45,0	<input type="checkbox"/> 47,0 <input checked="" type="checkbox"/> 49,0
	B	<input type="checkbox"/> 47,5	<input type="checkbox"/> 49,5 <input type="checkbox"/> 51,5
	A	<input type="checkbox"/> 50,0	<input type="checkbox"/> 52,0 <input type="checkbox"/> 54,0
<b>Camber angle</b>	2° <input checked="" type="checkbox"/>	0° <input type="checkbox"/>	

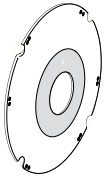
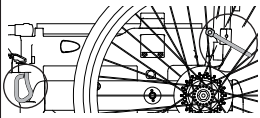
## Accessories Next

	<b>ARMREST SHORT</b> lockable, height-adjustable 25 cm long, (Included in standard features) solid top, black	right	81201 <input checked="" type="checkbox"/>
		left	81202 <input checked="" type="checkbox"/>
	<b>ARMREST LONG</b> lockable, height-adjustable 38 cm long, solid top, black	right	81203 <input type="checkbox"/>
		left	81204 <input type="checkbox"/>
	<b>ARMREST LOW</b> lockable, height-adjustable 25 cm long, solid top, black	right	26289-1 <input type="checkbox"/>
		left	26289-2 <input type="checkbox"/>
	lockable, height-adjustable 38 cm long, solid top, black	right	26290-1 <input type="checkbox"/>
		left	26290-2 <input type="checkbox"/>
	<b>ARMREST COVER</b> dark grey plush, detachable, 25 or 38 cm long	padded	short      quantity___      62282-60 <input type="checkbox"/>
		gel	long      quantity___      62283-60 <input type="checkbox"/>
			short      quantity___      26240-60 <input type="checkbox"/>
			long      quantity___      26241-60 <input type="checkbox"/>
	<b>ARMREST CUSHION</b> wide and soft to be mounted on existing arm supports	size	8 cm x 40 cm      26873 <input type="checkbox"/>
	<b>ARMREST CUSHION HEMI</b> to be fitted on long arm supports only!	right	25770-60-1 <input type="checkbox"/>
		left	25770-60-2 <input type="checkbox"/>
	<b>TRAY</b> to be mounted on long arm supports seat width cm	35      24417 <input type="checkbox"/>	47,5      25731 <input type="checkbox"/>
		37,5      25187 <input type="checkbox"/>	50      24601 <input type="checkbox"/>
		40      24418 <input type="checkbox"/>	52,5      26020 <input type="checkbox"/>
		42,5      25188 <input type="checkbox"/>	55      26021 <input type="checkbox"/>
		45      24419 <input type="checkbox"/>	57,5      26022 <input type="checkbox"/>
	<b>TABLE HEMI</b> incl. cover with velcro lock seat width cm      arm support short	35      26556 <input type="checkbox"/>	arm support long      35      26563 <input type="checkbox"/>
		37,5      26557 <input type="checkbox"/>	37,5      26564 <input type="checkbox"/>
		40      26558 <input type="checkbox"/>	40      26565 <input type="checkbox"/>
		42,5      26559 <input type="checkbox"/>	42,5      26566 <input type="checkbox"/>
		45      26560 <input type="checkbox"/>	45      26567 <input type="checkbox"/>
		47,5      26561 <input type="checkbox"/>	47,5      26568 <input type="checkbox"/>
		50      26562 <input type="checkbox"/>	50      26569 <input type="checkbox"/>
	<b>ANTI GLIDE TABLE HEMI</b>	35-40 cm      quantity___	81633 <input type="checkbox"/>
		42,5-50 cm      quantity___	81634 <input type="checkbox"/>

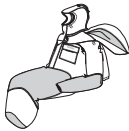
	<p>CUSHION dark grey plush, 56 cm long anatomically shaped cut to individual seat depth</p> <p>COMFORT WEDGE increases the anatomically shape (To be placed in the upholstery pocket)</p>	<p>seat width cm</p> <p>35 37,5 40 42,5 45 47,5 50 52,5 55 57,5</p> <p>seat width cm</p> <p>35-37,5 40-45 47,5-50</p>	<p>62230-60 <input type="checkbox"/></p> <p>62231-60 <input type="checkbox"/></p> <p>62232-60 <input type="checkbox"/></p> <p>62233-60 <input type="checkbox"/></p> <p>62234-60 <input type="checkbox"/></p> <p>62374-60 <input type="checkbox"/></p> <p>62266-60 <input type="checkbox"/></p> <p>62420-60 <input type="checkbox"/></p> <p>62421-60 <input type="checkbox"/></p> <p>62422-60 <input type="checkbox"/></p> <p>80714 <input type="checkbox"/></p> <p>80715 <input type="checkbox"/></p> <p>80779 <input type="checkbox"/></p>				
<p>ECS seat and backsupport (see separate sheet) The seat- and back support system offers products and covers in different kinds of upholstery and fabrics.</p>							
	<p>COVER black Dartex Fits only on calf support for elevating legrest with foldable calf support</p>		<p>62762-63 <input type="checkbox"/></p>				
	<p>CALF STRAP detachable, adjustable in length</p> <p>PADDING for calf strap</p>	<p>seat width cm</p> <p>35-37,5 40-42,5 45-47,5 50-52,5 55-57,5</p> <p>20 cm 30 cm 40 cm</p>	<p>25356 <input type="checkbox"/></p> <p>25357 <input type="checkbox"/></p> <p>25358 <input type="checkbox"/></p> <p>25359 <input type="checkbox"/></p> <p>26062 <input type="checkbox"/></p> <p>26845 <input type="checkbox"/></p> <p>26846 <input type="checkbox"/></p> <p>26847 <input type="checkbox"/></p>				
	<p>EXTENDED FOOT SUPPORT mounted on foot supports</p>	<p>seat width cm</p> <p>40-42,5 45-47,5 50</p> <p>quantity____ quantity____ quantity____</p>	<p>50798 <input type="checkbox"/></p> <p>50799 <input type="checkbox"/></p> <p>50800 <input type="checkbox"/></p>				
	<p>HEEL STRAP adjustable in length</p>		<p>right 24458 <input type="checkbox"/></p> <p>left 24458 <input type="checkbox"/></p>				
	<p>POSITIONING BELT two-part with snap-lock, attachment points on wheelchair frame</p>		<p>26273 <input type="checkbox"/></p>				
	<p>HEAD SUPPORT incl. tube, to be mounted on bow handle, adjustable in height, depth and angle</p>		<p>black Dartex 24462-63 <input type="checkbox"/></p> <p>grey plush 24462-60 <input type="checkbox"/></p>				
<p>HEAD SUPPORT incl. adjustable tube 45° to be mounted on bow handle</p> <table border="0" style="width: 100%;"> <tr> <td style="width: 25%; vertical-align: top;">  <p>With side support 320(240inv)x170 mm 405766 <input type="checkbox"/></p> </td> <td style="width: 25%; vertical-align: top;">  <p>Curved 250x140 mm 405761 <input type="checkbox"/></p> </td> <td style="width: 25%; vertical-align: top;"> <p>Height adjustable tube</p> <p>45° 406255 <input type="checkbox"/></p> <p>90° 400260 <input type="checkbox"/></p> <p>curved 400262 <input type="checkbox"/></p> </td> <td style="width: 25%; vertical-align: top;">    </td> </tr> </table>				 <p>With side support 320(240inv)x170 mm 405766 <input type="checkbox"/></p>	 <p>Curved 250x140 mm 405761 <input type="checkbox"/></p>	<p>Height adjustable tube</p> <p>45° 406255 <input type="checkbox"/></p> <p>90° 400260 <input type="checkbox"/></p> <p>curved 400262 <input type="checkbox"/></p>	  
 <p>With side support 320(240inv)x170 mm 405766 <input type="checkbox"/></p>	 <p>Curved 250x140 mm 405761 <input type="checkbox"/></p>	<p>Height adjustable tube</p> <p>45° 406255 <input type="checkbox"/></p> <p>90° 400260 <input type="checkbox"/></p> <p>curved 400262 <input type="checkbox"/></p>	  				

	HEAD SUPPORT BRACKET for bow handle <span style="float: right;">25795 <input type="checkbox"/></span>																																								
	<table border="0"> <tr> <td>BACKREST BRACE</td> <td>seat width cm</td> <td>35</td> <td>25610</td> <td><input type="checkbox"/></td> <td>47,5</td> <td>25739</td> <td><input type="checkbox"/></td> </tr> <tr> <td>with snap-lock</td> <td></td> <td>37,5</td> <td>25611</td> <td><input type="checkbox"/></td> <td>50</td> <td>25615</td> <td><input type="checkbox"/></td> </tr> <tr> <td></td> <td></td> <td>40</td> <td>25612</td> <td><input type="checkbox"/></td> <td>52,5</td> <td>26030</td> <td><input type="checkbox"/></td> </tr> <tr> <td></td> <td></td> <td>42,5</td> <td>25613</td> <td><input type="checkbox"/></td> <td>55</td> <td>26031</td> <td><input type="checkbox"/></td> </tr> <tr> <td></td> <td></td> <td>45</td> <td>25614</td> <td><input type="checkbox"/></td> <td>57,5</td> <td>26032</td> <td><input type="checkbox"/></td> </tr> </table>	BACKREST BRACE	seat width cm	35	25610	<input type="checkbox"/>	47,5	25739	<input type="checkbox"/>	with snap-lock		37,5	25611	<input type="checkbox"/>	50	25615	<input type="checkbox"/>			40	25612	<input type="checkbox"/>	52,5	26030	<input type="checkbox"/>			42,5	25613	<input type="checkbox"/>	55	26031	<input type="checkbox"/>			45	25614	<input type="checkbox"/>	57,5	26032	<input type="checkbox"/>
BACKREST BRACE	seat width cm	35	25610	<input type="checkbox"/>	47,5	25739	<input type="checkbox"/>																																		
with snap-lock		37,5	25611	<input type="checkbox"/>	50	25615	<input type="checkbox"/>																																		
		40	25612	<input type="checkbox"/>	52,5	26030	<input type="checkbox"/>																																		
		42,5	25613	<input type="checkbox"/>	55	26031	<input type="checkbox"/>																																		
		45	25614	<input type="checkbox"/>	57,5	26032	<input type="checkbox"/>																																		
	<table border="0"> <tr> <td>BACK SUPPORT WEDGE dark grey plush</td> <td>short 15 cm</td> <td>quantity_____</td> <td>62346-60</td> <td><input type="checkbox"/></td> </tr> <tr> <td></td> <td>long 30 cm</td> <td>quantity_____</td> <td>62347-60</td> <td><input type="checkbox"/></td> </tr> <tr> <td>ANTI-TIPS (Included in standard features)</td> <td></td> <td>quantity_2_</td> <td>25969</td> <td><input checked="" type="checkbox"/></td> </tr> <tr> <td>for low seat height 20" rear wheels</td> <td></td> <td>quantity_____</td> <td>26132</td> <td><input type="checkbox"/></td> </tr> <tr> <td>ANTI-TIPS telescoping</td> <td>For 20" to 24" rear wheels</td> <td>quantity_____</td> <td>26895</td> <td><input type="checkbox"/></td> </tr> </table>	BACK SUPPORT WEDGE dark grey plush	short 15 cm	quantity_____	62346-60	<input type="checkbox"/>		long 30 cm	quantity_____	62347-60	<input type="checkbox"/>	ANTI-TIPS (Included in standard features)		quantity_2_	25969	<input checked="" type="checkbox"/>	for low seat height 20" rear wheels		quantity_____	26132	<input type="checkbox"/>	ANTI-TIPS telescoping	For 20" to 24" rear wheels	quantity_____	26895	<input type="checkbox"/>															
BACK SUPPORT WEDGE dark grey plush	short 15 cm	quantity_____	62346-60	<input type="checkbox"/>																																					
	long 30 cm	quantity_____	62347-60	<input type="checkbox"/>																																					
ANTI-TIPS (Included in standard features)		quantity_2_	25969	<input checked="" type="checkbox"/>																																					
for low seat height 20" rear wheels		quantity_____	26132	<input type="checkbox"/>																																					
ANTI-TIPS telescoping	For 20" to 24" rear wheels	quantity_____	26895	<input type="checkbox"/>																																					
	<table border="0"> <tr> <td>CANE HOLDER Universal</td> <td>right</td> <td>27327</td> <td><input type="checkbox"/></td> </tr> <tr> <td></td> <td>left</td> <td>27327</td> <td><input type="checkbox"/></td> </tr> </table>	CANE HOLDER Universal	right	27327	<input type="checkbox"/>		left	27327	<input type="checkbox"/>																																
CANE HOLDER Universal	right	27327	<input type="checkbox"/>																																						
	left	27327	<input type="checkbox"/>																																						
	<table border="0"> <tr> <td>SPOKE GUARD</td> <td>with grey logo</td> <td>20"</td> <td>25502-28</td> <td><input type="checkbox"/></td> </tr> <tr> <td></td> <td></td> <td>22"</td> <td>25503-28</td> <td><input type="checkbox"/></td> </tr> <tr> <td></td> <td></td> <td>24"</td> <td>25504-28</td> <td><input type="checkbox"/></td> </tr> <tr> <td></td> <td>with yellow logo</td> <td>20"</td> <td>25502-29</td> <td><input type="checkbox"/></td> </tr> <tr> <td></td> <td></td> <td>22"</td> <td>25503-29</td> <td><input type="checkbox"/></td> </tr> <tr> <td></td> <td></td> <td>24"</td> <td>25504-29</td> <td><input type="checkbox"/></td> </tr> </table> <p>Other spoke guards on see <a href="http://www.etac.se">www.etac.se</a></p>	SPOKE GUARD	with grey logo	20"	25502-28	<input type="checkbox"/>			22"	25503-28	<input type="checkbox"/>			24"	25504-28	<input type="checkbox"/>		with yellow logo	20"	25502-29	<input type="checkbox"/>			22"	25503-29	<input type="checkbox"/>			24"	25504-29	<input type="checkbox"/>										
SPOKE GUARD	with grey logo	20"	25502-28	<input type="checkbox"/>																																					
		22"	25503-28	<input type="checkbox"/>																																					
		24"	25504-28	<input type="checkbox"/>																																					
	with yellow logo	20"	25502-29	<input type="checkbox"/>																																					
		22"	25503-29	<input type="checkbox"/>																																					
		24"	25504-29	<input type="checkbox"/>																																					
	TRANSPORT ATTACHMENT complete set <span style="float: right;">26236 <input type="checkbox"/></span>																																								
	TOOLKIT <span style="float: right;">26204 <input type="checkbox"/></span>																																								

 <table border="0"> <tr> <td>BAGS</td> <td>92009</td> <td><input type="checkbox"/></td> </tr> <tr> <td>Backpack</td> <td>92010</td> <td><input type="checkbox"/></td> </tr> <tr> <td>Mobile holder</td> <td></td> <td></td> </tr> </table>	BAGS	92009	<input type="checkbox"/>	Backpack	92010	<input type="checkbox"/>	Mobile holder			 RAINCAP Helly Hansen Pro For alternatives see <a href="http://www.etac.se">www.etac.se</a> Item no: _____
BAGS	92009	<input type="checkbox"/>								
Backpack	92010	<input type="checkbox"/>								
Mobile holder										
 COCOON Helly Hansen Pro For alternatives see <a href="http://www.etac.se">www.etac.se</a> Item no: _____	 LEG WARMER Helly Hansen Pro For alternatives see <a href="http://www.etac.se">www.etac.se</a> Item no: _____									
 GLOVES For alternatives see <a href="http://www.etac.se">www.etac.se</a> Item no: _____	 BAGS Case Logic For alternatives see <a href="http://www.etac.se">www.etac.se</a> Item no: _____									