

REF 8020 9229



Gejder engångsbäcken Grå

Holder disposable pan Grey

Halterung für Einweg-Steckbecken Grau

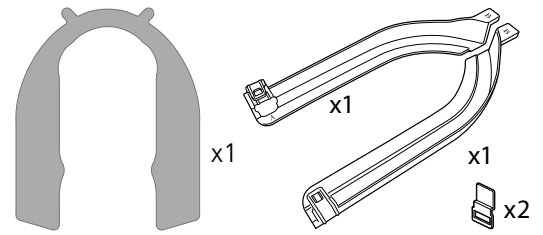

78511.3 2022-08-25

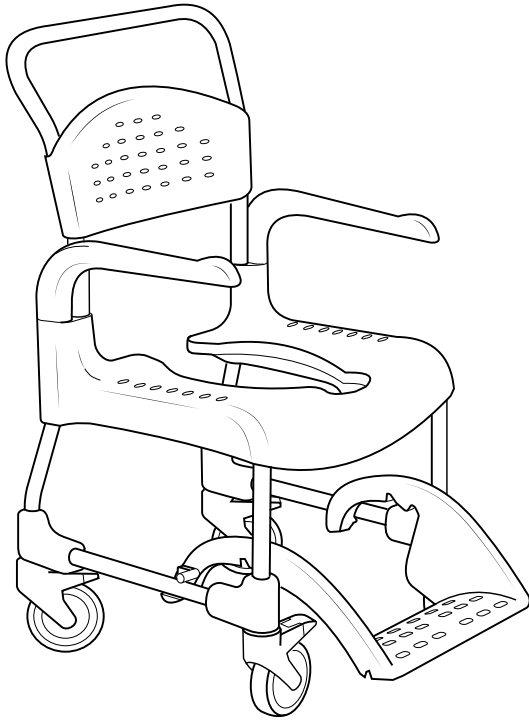

fr.o.m serie nr. / from serial no. / ab Serien Nr. 115120

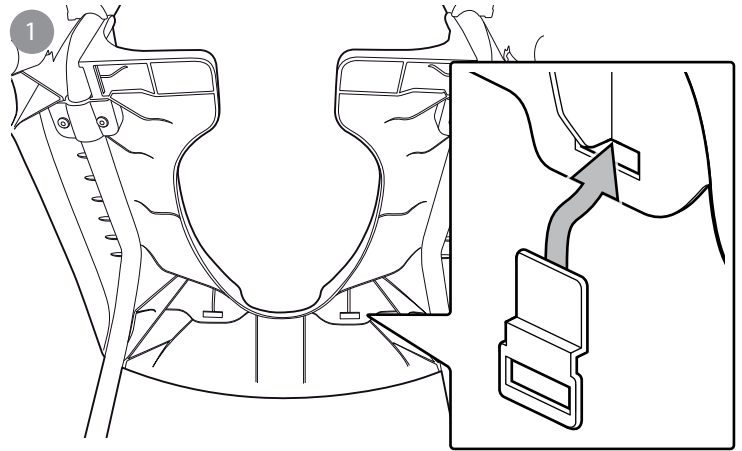

t.o.m serie nr. / up to serial no.
/ bis Serien Nr. 110335

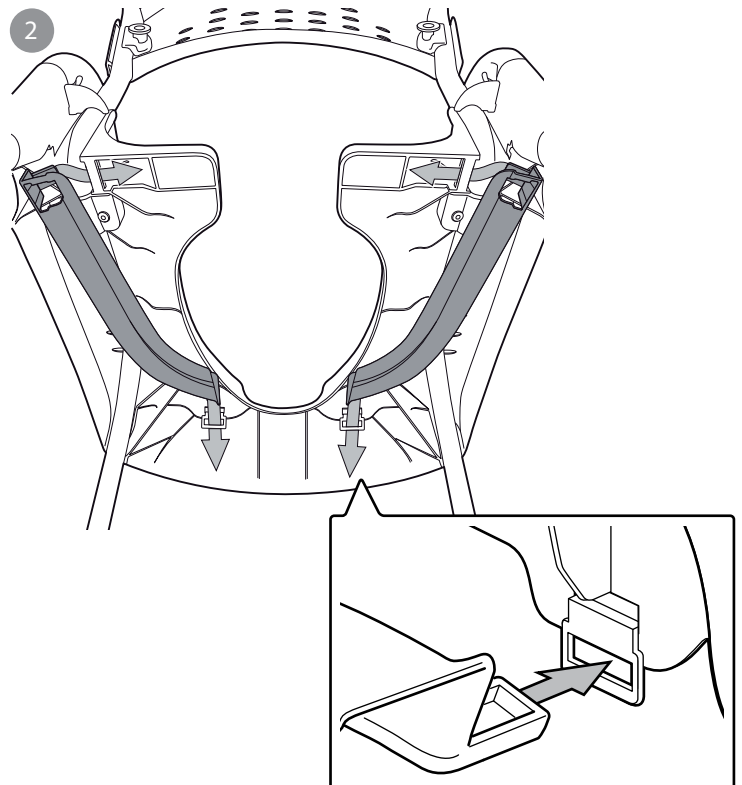
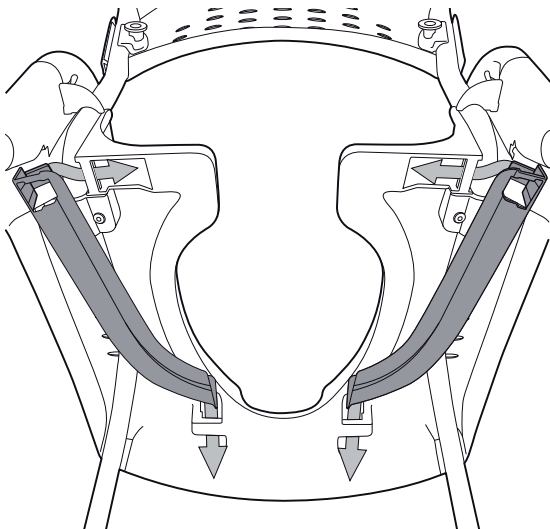

1

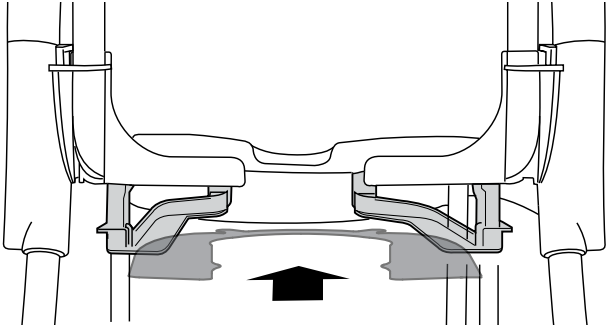

2

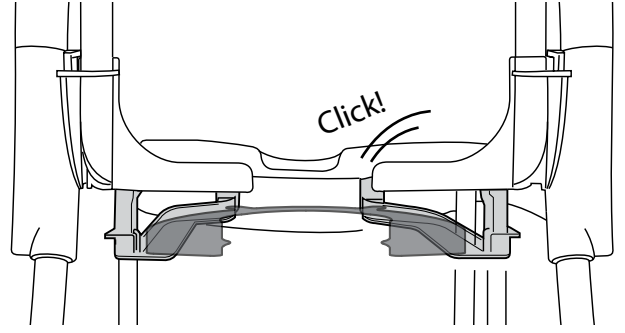

3

