

R82 Toucan - E0638

CAD Retail Price List/ Order Form

Account #: _____ Purchase Order No.: _____ Date: _____

Contact: _____ Mark For: _____

Bill To:	Ship To:
Address:	Address:
City/State/Zip:	
Phone:	City/State/Zip:
Email	Phone:

US Configuration

Effective: 11.05.2021 - Rev 4

- Toucan
- Footplate/Extra Foot Adj.
- Knee Support
- Hip/Side Support
- Back Support
- Chest Support
- Tray
- Head Support

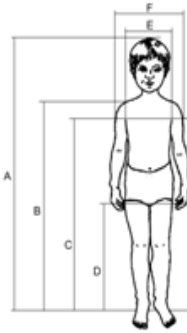

- A (Total Height) _____
- B (Shoulder Height) _____
- C (Chest Height) _____
- D (Buttock Height) _____
- E (Chest Width) _____
- F (Shoulder Width) _____
- Age _____
- Weight _____

Measurements

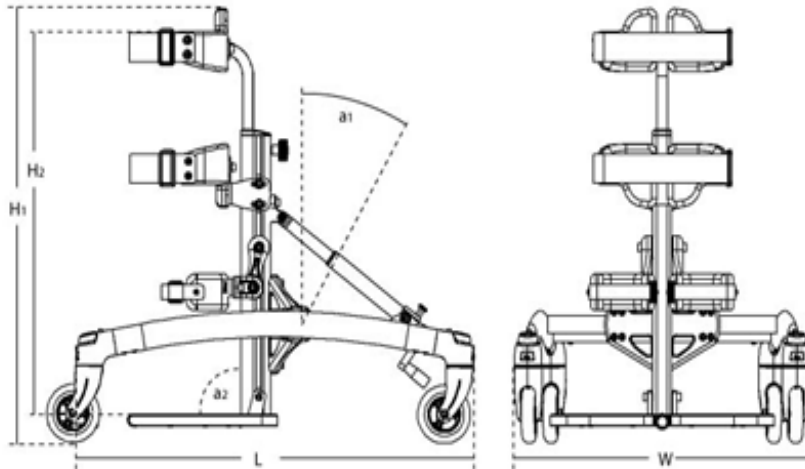

	Size 1 Inches	Size 2 Inches	Size 3 Inches	Size 4 Inches	Size 5 Inches
Width (G)	21¼"	24½"	24½"	27¼"	27¼"
Length (H)	29¼"	34¼"	34¼"	43¼"	43¼"
Total height (I1) *	26¼"-34"	28-39½"	37¾-48"	40½"-52¼"	48¼"-60"
Height from foot/chest (I2)	13¼"-27¼"	21-35"	29-43"	35½"-47¼"	43¼"-55"
Length, center bar	17½"	19½"	27½"	31¼"	39"
From floor to foot plate	2¼"	2¼"	2¼"	2½"	2½"
Angle of the center bar (a1)	0° to +30°	0° to +30°	0° to +30°	0° to +20°	0° to +20°
Angle of the foot plate (a2)	+15° to -10°	+15° to -10°	+15° to -10°	+15° to -10°	+15° to -10°
Weight	16½ lbs.	8½ lbs.	20 lbs.	10½ lbs.	24 lbs.
Max. user weight	67 lbs.	89 lbs.	111 lbs.	132 lbs.	154 lbs.
Approx. min. user height	24"	32"	42"	50½"	58½"
Approx. max. user height	38½"	42½"	56½"	62½"	71"





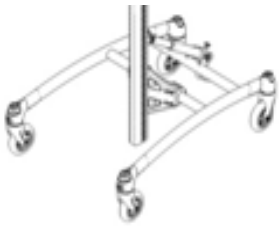



Toucan Standard Features





- Frame
- Castors
- Wheel Locks
- Center Bar
- Tilt Wind System

Description	Size	Part No.	CAD Price	HCPCS
□ Toucan Standing Frame, Red	1	861001	\$1,630	E0638
□ Toucan Standing Frame, Blue	2	861002	\$1,630	E0638
□ Toucan Standing Frame, Blue	3	861003	\$1,630	E0638
□ Toucan Standing Frame, Silver	4	861004	\$1,815	E0638
□ Toucan Standing Frame, Silver	5	861005	\$1,815	E0638

Accessories	Description	Measurements	Size	Part No.	CAD Price	HCPCS
	□ Chest Support	11" x 15½" x 7½"	1	861704	\$262	
	□ Chest Support **	11" x 20-27" x 7½"	2, 3	861702	\$262	
	□ Chest Support **	16" x 25-32" x 10½"	4, 5	861703	\$288	
	**Height and width adjustable					
	□ Chest Support (Pony Style) **	5½" x 8¾" x 4¾"	1	861801	\$377	
	□ Chest Support (Pony Style) **	5½" x 10¾" x 4¾"	2, 3	861802	\$377	
	□ Chest Support (Pony Style) **	5½" x 12¾" x 4¾"	4	861803	\$377	
	**Thicker Pad					
	□ Chest Support (Mustang Style) **	15½"-25¼"	Small	861810	\$626	
	□ Chest Support (Mustang Style) **	26¼"-30¾"	Medium	861820	\$652	
	□ Chest Support (Mustang Style) **	34¼"-44¾"	Large	861830	\$690	
	**Surrounding Pad Style					
	□ Extra Pad	H:4¾" x W:2¼"	One Size	869225	\$78	
	For Mustang Style Chest Support					
	□ Cover for Chest Support		Small	869810-160	\$147	
	□ Cover for Chest Support		Medium	869820-260	\$179	
	□ Cover for Chest Support **		Large	869830-360	\$192	
	**Custom order; Approx. lead time: 6-8 weeks (sz Large)					
Description	Measurements	Size	Part No.	CAD Price	HCPCS	
	□ Filler Pad	4¼"	Small	861421	\$105	
	Adds 1" expansion to chest or hip pads					
	□ Filler Pad	6¼"	Large	861422	\$105	
	Adds 2" expansion to chest or hip pads					
	□ Tray with Storage Box		One Size	862501	\$505	
	□ Height Adjustment of Tray		One Size	862510	\$288	

Accessories	Description	Measurements	Size	Part No.	CAD Price	HCPCS
	□ Tray, Plastic, w/Bowl and Plate	24" x 22½"	1	861121	\$646	
	□ Tray, Plastic, w/Bowl and Plate	24" x 22½"	2	861122	\$646	
	□ Tray, Plastic, w/Bowl and Plate	24" x 22½"	3	861123	\$646	
	□ Tray, Plastic, w/Bowl and Plate	24" x 22½"	4	861124	\$646	
	□ Tray, Plastic, w/Bowl and Plate	24" x 22½"	5	861125	\$646	



□ Armrest for Plastic Tray w/ Bowl	9½" x 12½"	One Size	861131	\$205
□ Toy Bar for Plastic Tray w/ Bowl		One Size	861135	\$307
□ Grip Handle		One Size	8910750	\$518
<i>*Custom order; Approx. lead time: 6-8 weeks. Non-returnable item</i>				
□ Tray, Plastic, Grey		One Size	862515	\$492

Description	Measurements	Size	Part No.	CAD Price	HCPCS
-------------	--------------	------	----------	-----------	-------

All Hip Supports include a strap



□ Hip Support w/ Pommel ♦	4¼" x 6" x 3"	1	861501	\$646
□ Hip Support w/ Pommel •	4¼" x 8-10½" x 3"	2, 3	861502	\$646
□ Hip Support w/ Pommel •	6¼" x 10-11½" x 4"	4	861503	\$716
♦ <i>Height Adjustable</i>				
• <i>Height and Width Adjustable</i>				



□ Hip Support, Front Mount ♦	4¼" x 6" x 3"	1	861601	\$300
□ Hip Support, Front Mount •	4¼" x 8-10½" x 3"	2, 3	861602	\$300
□ Hip Support, Front Mount •	6¼" 10-11½" x 4"	4	861603	\$339
♦ <i>Height Adjustable</i>				
• <i>Height and Width Adjustable</i>				



□ Hip Support w/Rotation ♦	4¼" x 6" x 3"	1	861611	\$454
□ Hip Support w/Rotation •	4¼" x 8-10½" x 3"	2, 3	861612	\$454
□ Hip Support w/Rotation •	6¼" x 10-11½" x 4"	4	861613	\$492
♦ <i>Height Adjustable</i>				
• <i>Height and Width Adjustable</i>				



□ Hip Support, Surrounding ••		1	861610	\$709
□ Hip Support, Surrounding		2, 3	861620	\$709
□ Hip Support, Surrounding ••		4	861630	\$722
•• <i>Custom Order; Approx. lead time: 6-8 weeks.</i>				



□ Extension for Center Bar (Ea.)	3¼"	One Size	861480	\$105
----------------------------------	-----	----------	--------	-------



□ Abdominal Support (Ea.)	5" x 7½"	One Size	861411	\$205
---------------------------	----------	----------	--------	-------

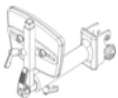

□ Pommel and Sacral Support (Ea.)	5" x 7½"	One Size	861401	\$556
-----------------------------------	----------	----------	--------	-------

Accessories	Description	Measurements	Size	Part No.	CAD Price	HCPCS
-------------	-------------	--------------	------	----------	-----------	-------

NOTE → The following items are required when ordering a Head Support:

- Connecting System for Head Support
- Headrest of Choice
- Turtle Bar System
- Hip Support w/ Pommel

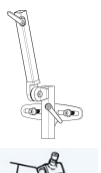

□ Connecting System for Head Support ♦		1, 2	861424-3	\$264
□ Connecting System for Head Support ♦		3, 4	861424-4	\$264
♦ <i>Required with Head Support</i>				

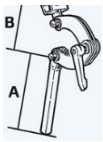



Swing-away Mounting Brackets - Height, Depth, Angle and Lateral Adjustable

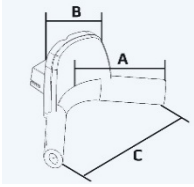



- Turtle Bar System ♦ A: 5", B: 4-8½" Short 98619-25 \$294
 - Turtle Bar System ♦ A: 10", B: 4-8½" Long 98619-26 \$294
- ♦ **Required with Anatomic Head Support; 5099001, 5099002 or 5099003**



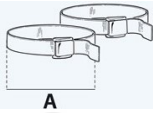

- Anatomic Head Support ♦ A:5½ x B:5½ x C:9½" Small 5099001 \$326
 - Head Support Cover (Required) Small 9923-83 N/C
 - Anatomic Head Support ♦ A:6 x B:5½ x C:10" Medium 5099002 \$326
 - Head Support Cover (Required) Medium 9945-83 N/C
 - Anatomic Head Support ♦ A:6½ x B:5½ x C:12½" Large 5099003 \$326
 - Head Support Cover (Required) Large 9967-83 N/C
- ♦ **Turtle Bar System Short or Long Required; 98619-25 or 98619-26**

Other types of headrest available, please see Head Supports Order Form

Description	Measurements	Size	Part No.	CAD Price	HCPCS
 □ Knee Supports (Pr.) ♦ □ Knee Supports (Pr.) ♦ □ Knee Supports (Pr.) ♦	2½" x 2½"	1	861301	\$358	
	2¾" x 3¼"	2, 3	861302	\$454	
	2¾" x 4"	4, 5	861303	\$454	
♦ Includes Straps					
 □ Hinged Knee Supports (Pr.) ♦ □ Hinged Knee Supports (Pr.) ♦ □ Hinged Knee Supports (Pr.) ♦	3"	1	861311	\$556	
	3¾"	2, 3	861312	\$556	
	4½"	4, 5	861313	\$556	
♦ Includes Straps					
 □ Individual Footrest w/Hinged Sandals ♦ □ Individual Footrest w/Hinged Sandals ♦		1	861201	\$505	
		2, 3	861202	\$505	
♦ Includes Straps					

Accessories	Description	Measurements	Size	Part No.	CAD Price	HCPCS
 □ Flip-up Footplate ♦ □ Flip-up Footplate ♦		12" x 12"	1	861211	\$281	
		17" x 14"	2, 3, 4, 5	861212	\$281	
♦ Required with all Footplate Accessories						
 □ Formed Footplates (Pr.) ♦ □ Formed Footplates (Pr.) ♦ □ Formed Footplates (Pr.) ♦		6¾"	0	86149	\$211	
		4" x 8½"	1, 2	86147	\$211	
		4½" x 9½"	3	86148	\$211	
♦ Flip-Up Footplate Required; 861211 or 861212						
 □ Foot Straps, Plastic Lock (Pr.) □ Foot Straps, Velcro (Pr.)		Max: 22", A: 13½-20½"	One Size	85096	\$46	
			One Size	85102	\$65	
 □ Hinged Sandals w/Straps ♦ □ Hinged Sandals w/Straps ♦ □ Hinged Sandals w/Straps ♦		3¾" x 8"	1	861221	\$173	
		4½" x 9½"	2, 3	861222	\$173	
		6" x 12"	4, 5	861223	\$173	
♦ Flip-Up Footplate Required; 861211 or 861212						

Accessories	Description	Measurements	Size	Part No.	CAD Price	HCPCS
 □ Heel Stop ♦ □ Heel Stop ♦		1½" x 4"	Small	861251	\$72	
		4" x 5¾"	Large	861252	\$72	
♦ Flip-Up Footplate Required; 861211 or 861212						

Spare Parts	Description	Measurements	Size	Part No.	CAD Price	HCPCS
 □ Strap for Hip Support □ Strap for Hip Support □ Strap for Hip Support			1	861621	\$78	
			2, 3	861622	\$78	
			4, 5	861623	\$78	
 □ Kit for Center Bar ♦♦			2	861902	\$205	



□ Kit for Center Bar ●●	3	861903	\$224
□ Kit for Center Bar ●●	4	861904	\$249
□ Kit for Center Bar ●●	5	861905	\$288

●●*Custom order; Approx. lead time: 6-8 weeks*



□ Mounting for Back Support	One Size	861451	\$170
-----------------------------	----------	--------	-------



□ Straps for Knee Supports (Pr.)	1	861341	\$72
□ Straps for Knee Supports (Pr.)	2, 3	861342	\$72



□ Straps for Flip-Up Footplate (Pr.)	1	861241	\$112
□ Straps for Flip-Up Footplate (Pr.)	2, 3	861242	\$112
□ Straps for Flip-Up Footplate (Pr.)	4, 5	861243	\$112

HCPCS codes are provided for your convenience and are NOT to be considered billing or legal advice. Providers are responsible for insuring that all appropriate billing codes are used when submitting claims. Proper use of HCPCS codes does not insure coverage or payment. Contact the appropriate payer for coverage information.

Prices in CAD & is subject to change without notice

For Quotes and Orders please send completed Order Form to: sales.us@etac.com or fax: 1-800-760-0537

Etac
 13137 Bleinheim Lane
 Matthews, North Carolina 28105
 +1 844-US-MOBILITY (844-876-6245)
www.etac.us.com

OF6402-ENG-REV.04

