

R82 Manatee

CAD Retail Price List/ Order Form

Account #: _____ Purchase Order No.: _____ Date: _____
 Contact: _____ Mark For: _____

Bill To:	Ship To:
Address:	Address:
City/State/Zip:	
Phone:	City/State/Zip:
Email	Phone:

US Configuration

Effective: 05.01.21- Rev 4

- Manatee
- Head support
- Leg belts
- Frame



- A (Back Height) _____
- B (Arm Height) _____
- C (Lower Leg Length) _____
- D (Seat Depth) _____
- E (Chest Width) _____
- F (Seat Width) _____
- G (Height-Seat to Top of Head) _____
- H (Shoulder Width) _____
- Age _____
- Weight _____

Measurements

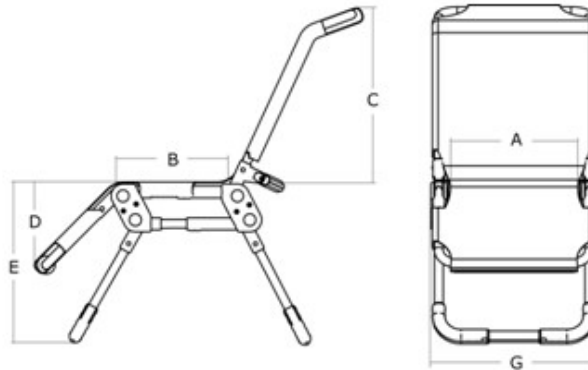

Manatee

	Size 0 Inches	Size 1 Inches	Size 2 Inches	Size 3 Inches
Seat Width (A)	12 ³ / ₄ "	12 ³ / ₄ "	12 ³ / ₄ "	15 ¹ / ₂ "
Seat Depth (B)	8 ¹ / ₂ - 9 ³ / ₄ "	11 ³ / ₄ - 14 ¹ / ₂ "	15 ¹ / ₄ - 18"	15 ¹ / ₂ "-18 ¹ / ₄ "
Back Height (C)	16 ³ / ₄ "	16 ³ / ₄ "	22 ¹ / ₂ "	25"
Lower Leg Length (D)	11"	11"	13 ¹ / ₄ "	13 ¹ / ₄ "
Seat Height (E)	5 ¹ / ₂ - 16 ³ / ₄ "	5 ¹ / ₂ - 16 ³ / ₄ "	5 ¹ / ₂ - 16 ³ / ₄ "	5 ¹ / ₂ -16 ³ / ₄ "
Total Width (G)	16 ¹ / ₂ "	16 ¹ / ₂ "	16 ¹ / ₂ "	19"
Length Folded	"40 - 43"	43 - 45 ³ / ₄ "	53 - 55 ³ / ₄ "	56-58 ³ / ₄ "
Height Folded	5"	5"	5"	5"
Weight	12 lbs.	12 lbs.	13.25 lbs.	15 ¹ / ₂ "
Max. Load	110 lbs.	110 lbs.	165 lbs.	165 lbs.

Measurements

Frames	Shower Frame	Bath Tub Frame
Width	23"	17"
Length	38¼"	28½" - 43¼"
Height, Seat to Floor	29½", 32½", 35½"	25½"
Storage Height	8"	10½"
Weight	17½ lbs.	4½ lbs.
Max. Load	165 lbs.	165 lbs.



Manatee Standard Features



- Manatee comes in 4 sizes; 0, 1, 2 or 3
- Head/Lateral Support
- Height Adjustable Foldable Frame
- Cover in Red or Blue Soft Nylon
- Belt for Waist/Hip
- HCPCS n/a for Manatee

Description	Size	Part No.	CAD Price
Required, must select a color			
X = Color			
<input type="checkbox"/> Blue = 5			
<input type="checkbox"/> Red = 4			
<input type="checkbox"/> Manatee, Blue *	0	882005	\$895
<input type="checkbox"/> Manatee	1	88201X	\$895
<input type="checkbox"/> Manatee	2	88202X	\$895
<input type="checkbox"/> Manatee	3	88203X	\$978

* Size 0 is only available in Blue





Frame	Description	Size	Part No.	CAD Price
	<input type="checkbox"/> Basic Manatee Frame	One Size	882101	\$447
	<input type="checkbox"/> Rolling Shower Frame	One Size	882100	\$908
	<input type="checkbox"/> Wall Mount for Frame	One Size	882110	\$198
Required, must select a color				
X = Color				
	<input type="checkbox"/> Blue = 5			
	<input type="checkbox"/> Red = 4			
	<input type="checkbox"/> Net for Frame *	One Size	88210X	\$91

*Custom order; Approx. lead time: 6-8 weeks

IMPORTANT: No returns or exchanges accepted for this product

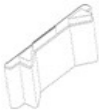
Frame	Description	Size	Part No.	CAD Price
	<input type="checkbox"/> Tub Slider without Manatee w/ Casters (W: 50") *	1, 2	MC6000PED	\$4,173
	<input type="checkbox"/> Tub Slider without Manatee w/ Casters (W: 50")	3	MC6200PED	\$5,087

*Custom order; Approx. lead time: 6-8 weeks. Non-returnable item

Accessories	Description	Measurements	Size	Part No.	CAD Price
	Required, must select a color				
	X = Color				
	<input type="checkbox"/> Blue = 5				
	<input type="checkbox"/> Red = 4				
	<input type="checkbox"/> Head/Lateral Support		0, 1, 2	88301X	\$141
	<input type="checkbox"/> Head/Lateral Support		3	88306X	\$141
	<input type="checkbox"/> Torso Belt		0, 1, 2	88302X	\$99
	<input type="checkbox"/> Torso Belt		3	88307X	\$99
	<input type="checkbox"/> Leg Straps		0, 1, 2	88305X	\$99
	<input type="checkbox"/> Leg Straps		3	88310X	\$124
	<input type="checkbox"/> Pommel		0, 1, 2	88304X	\$124
	<input type="checkbox"/> Pommel *		3	88309X	\$124
	<i>*Pommel sz 3 in RED is a custom order; Approx. lead time: 6-8 weeks</i>				

Spare Parts	Description	Measurements	Size	Part No.	CAD Price
	<input type="checkbox"/> Belt for Waist/Hip		0, 1, 2	88303X	\$99
	<input type="checkbox"/> Belt for Waist/Hip		3	88308X	\$99
	Required, must select a color				
	X = Color				
	<input type="checkbox"/> Blue = 5				
	<input type="checkbox"/> Red = 4				
	<input type="checkbox"/> Cover *		0	882205	\$326
	<input type="checkbox"/> Cover		1	88221X	\$326
	<input type="checkbox"/> Cover		2	88222X	\$326
	<input type="checkbox"/> Cover		3	88223X	\$326
	<i>* Size 0 is only available in Blue</i>				

IMPORTANT: No returns or exchanges accepted for this product

Prices in CAD & is subject to change without notice

For Quotes and Orders please send completed Order Form to: sales.us@etac.com or fax: 1-800-760-0537

OF5602-ENG-REV.04

Etac
13137 Bleinheim Lane
Matthews, North Carolina 28105
+1 844-US-MOBILITY (844-876-6245)
www.etac.us.com

Creating Possibilities