



8020 9524



Hip-/Chest belt, upholstered

Höft-/brösthälsa, polstrat

Becken-/Brustgurt, gepolstert

Heup-/Borstband met polstering

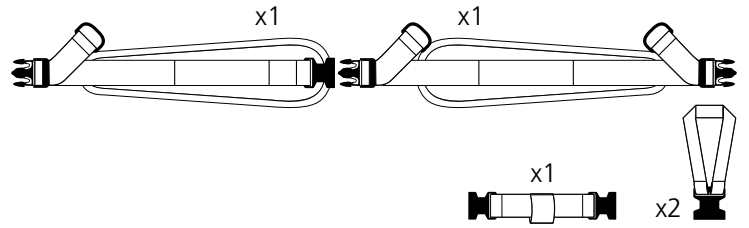

1a16263.5 2023-02-03

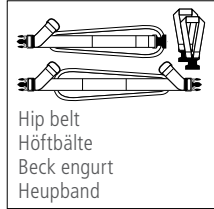

Hip belt
Höftbälte
Beck engurt
Heupband

Swift Mobil (1-3A)

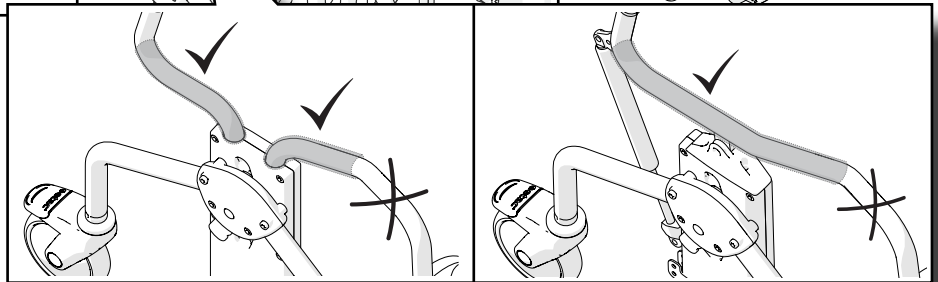
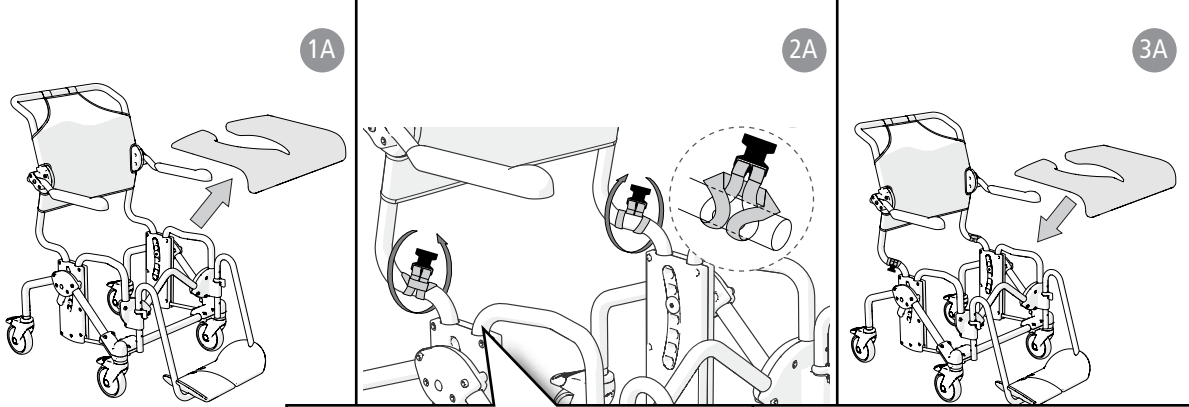

Clean (1B-C)

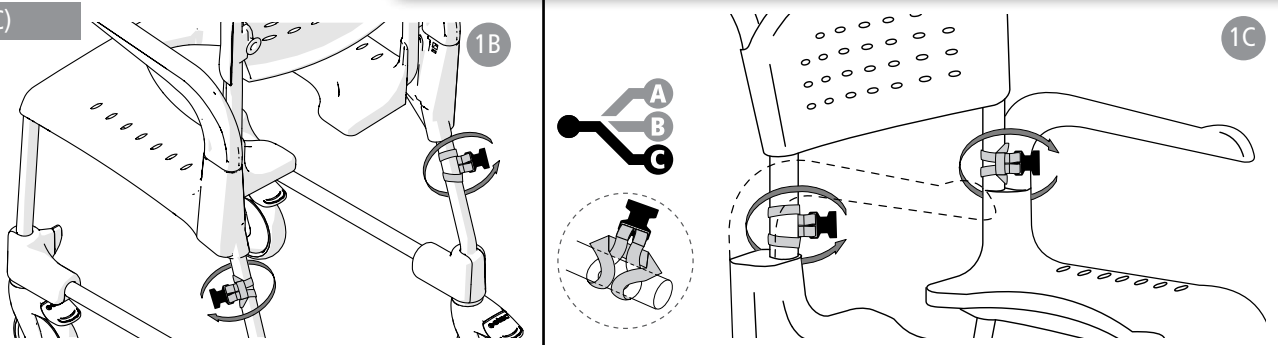
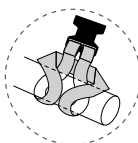
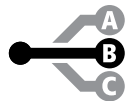

Swift Mobil,
Clean (4-6)

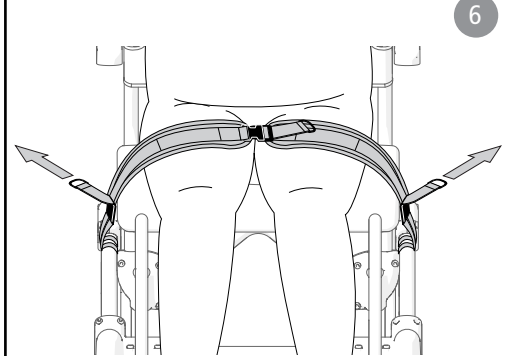
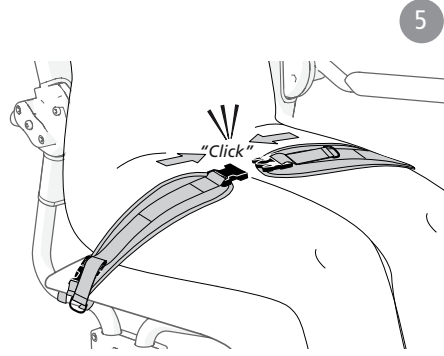
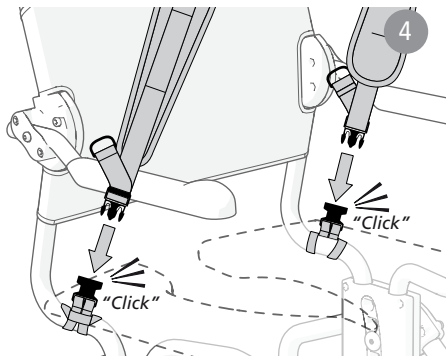

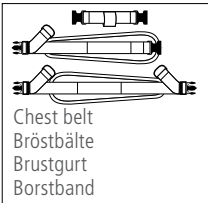

Swift Mobil

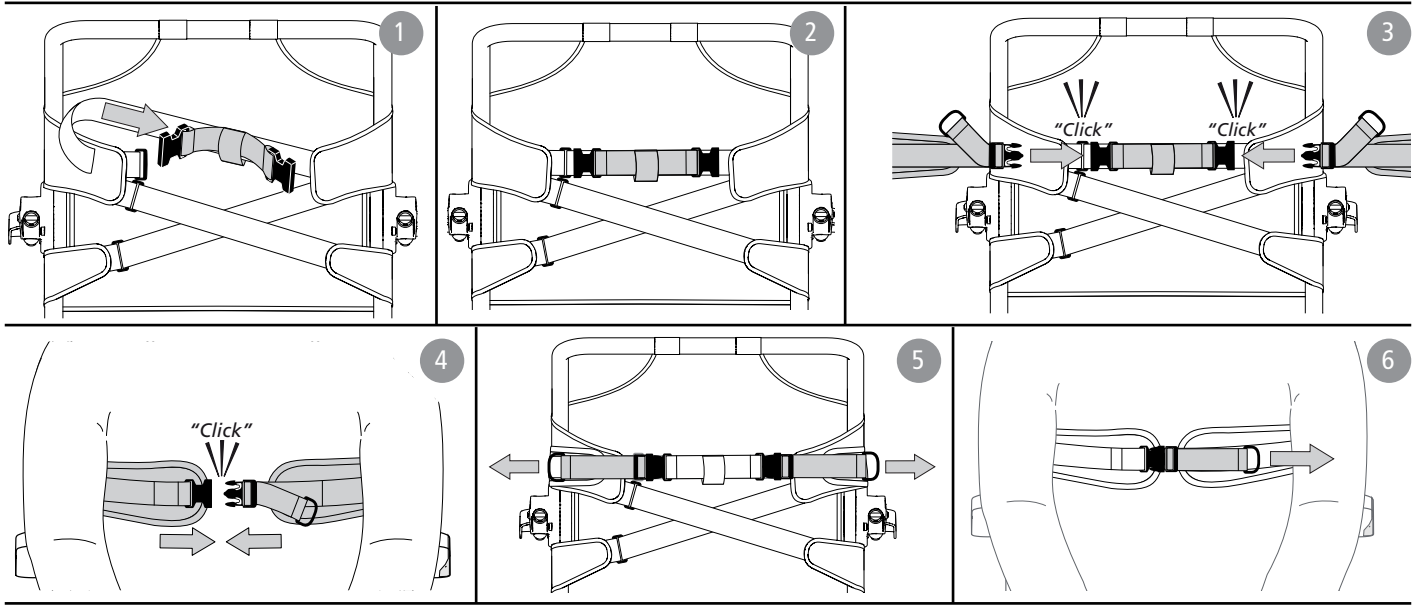

Clean

